

# SKiiP 25NABI066V3



## MiniSKiiP® CIB IPM

3-phase bridge rectifier +  
brake chopper + 3-phase  
bridge inverter

intelligent power module

### SKiiP 25NABI066V3

#### Features

- Contact springs for solder-free and quick assembly
- Trench-Field-Stop IGBT
- Freewheeling diodes in CAL technology
- HVIC gate driver in SOI technology with advanced level shifter
- Matched propagation delay
- Over-current and under-voltage detection
- Interlock logic for cross conduction protection
- Multi-purpose error input
- Integrated temperature sensor (NTC)
- RoHs compliant
- UL recognised file no. E63532

#### Typical Applications\*

- Industrial & consumer drives
- Power supplies (SMPS & UPS)

#### Remarks

- Product reliability results valid for  $T_j \leq 150^\circ\text{C}$
- Case temp. limited to  $T_c = 125^\circ\text{C}$  max. (for baseplateless modules  $T_c = T_s$ )

#### Footnotes

- <sup>1)</sup> Please refer to Technical Explanations

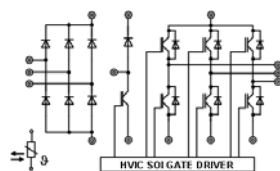

NABI

Absolute Maximum Ratings				
Symbol	Conditions	Values	Unit	
<b>Inverter - IGBT</b>				
$V_{CES}$	$T_j = 25^\circ\text{C}$	600	V	
$I_C$	$T_j = 150^\circ\text{C}$	$T_s = 25^\circ\text{C}$	37	A
		$T_s = 70^\circ\text{C}$	28	A
$I_C$	$T_j = 175^\circ\text{C}$	$T_s = 25^\circ\text{C}$	41	A
		$T_s = 70^\circ\text{C}$	33	A
$I_{Cnom}$		30	A	
$I_{CRM}$	$I_{CRM} = 2 \times I_{Cnom}$	60	A	
$t_{psc}$	$V_{CC} = 360\text{ V}$ $V_{GE} \leq 15\text{ V}$ $V_{CES} \leq 600\text{ V}$	$T_j = 150^\circ\text{C}$	6	$\mu\text{s}$
$T_j$		-40 ... 175	$^\circ\text{C}$	
<b>Chopper - IGBT</b>				
$V_{CES}$	$T_j = 25^\circ\text{C}$	600	V	
$I_C$	$T_j = 150^\circ\text{C}$	$T_s = 25^\circ\text{C}$	37	A
		$T_s = 70^\circ\text{C}$	28	A
$I_C$	$T_j = 175^\circ\text{C}$	$T_s = 25^\circ\text{C}$	41	A
		$T_s = 70^\circ\text{C}$	33	A
$I_{Cnom}$		30	A	
$I_{CRM}$	$I_{CRM} = 2 \times I_{Cnom}$	60	A	
$t_{psc}$	$V_{CC} = 360\text{ V}$ $V_{GE} \leq 15\text{ V}$ $V_{CES} \leq 600\text{ V}$	$T_j = 150^\circ\text{C}$	6	$\mu\text{s}$
$T_j$		-40 ... 175	$^\circ\text{C}$	
<b>Inverse - Diode</b>				
$V_{RRM}$	$T_j = 25^\circ\text{C}$	600	V	
$I_F$	$T_j = 150^\circ\text{C}$	$T_s = 25^\circ\text{C}$	33	A
		$T_s = 70^\circ\text{C}$	25	A
$I_F$	$T_j = 175^\circ\text{C}$	$T_s = 25^\circ\text{C}$	37	A
		$T_s = 70^\circ\text{C}$	29	A
$I_{Fnom}$		30	A	
$I_{FRM}$	$I_{FRM} = 2 \times I_{Fnom}$	60	A	
$I_{FSM}$	$t_p = 10\text{ ms, sin } 180^\circ, T_j = 150^\circ\text{C}$	160	A	
$T_j$		-40 ... 175	$^\circ\text{C}$	
<b>Freewheeling - Diode</b>				
$V_{RRM}$	$T_j = 25^\circ\text{C}$	600	V	
$I_F$	$T_j = 150^\circ\text{C}$	$T_s = 25^\circ\text{C}$	33	A
		$T_s = 70^\circ\text{C}$	25	A
$I_F$	$T_j = 175^\circ\text{C}$	$T_s = 25^\circ\text{C}$	37	A
		$T_s = 70^\circ\text{C}$	29	A
$I_{Fnom}$		30	A	
$I_{FRM}$	$I_{FRM} = 2 \times I_{Fnom}$	60	A	
$I_{FSM}$	$t_p = 10\text{ ms, sin } 180^\circ, T_j = 150^\circ\text{C}$	160	A	
$T_j$		-40 ... 175	$^\circ\text{C}$	

# SKiiP 25NABI066V3



MiniSKiiP® CIB IPM

3-phase bridge rectifier +  
brake chopper + 3-phase  
bridge inverter  
intelligent power module

## SKiiP 25NABI066V3

### Features

- Contact springs for solder-free and quick assembly
- Trench-Field-Stop IGBT
- Freewheeling diodes in CAL technology
- HVIC gate driver in SOI technology with advanced level shifter
- Matched propagation delay
- Over-current and under-voltage detection
- Interlock logic for cross conduction protection
- Multi-purpose error input
- Integrated temperature sensor (NTC)
- RoHs compliant
- UL recognised file no. E63532

### Typical Applications\*

- Industrial & consumer drives
- Power supplies (SMPS & UPS)

### Remarks

- Product reliability results valid for  $T_j \leq 150^\circ\text{C}$
- Case temp. limited to  $T_c = 125^\circ\text{C}$  max. (for baseplateless modules  $T_c = T_s$ )

### Footnotes

<sup>1)</sup> Please refer to Technical Explanations

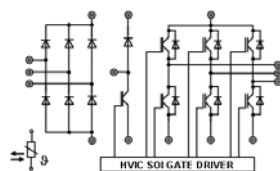

NABI

Absolute Maximum Ratings			
Symbol	Conditions	Values	Unit
<b>Rectifier - Diode</b>			
$V_{RRM}$	$T_j = 25^\circ\text{C}$ , chiplevel	1600	V
$I_F$	$T_s = 25^\circ\text{C}$ , $T_j = 150^\circ\text{C}$	43	A
$I_{FSM}$	10 ms	$T_j = 25^\circ\text{C}$	370
	sin 180°	$T_j = 150^\circ\text{C}$	270
$I^2t$	10 ms	$T_j = 25^\circ\text{C}$	685
	sin 180°	$T_j = 150^\circ\text{C}$	365
$T_j$		-40 ... 150	$^\circ\text{C}$
<b>Driver</b>			
VCC	VCC-VSS, VCCL-VSSL	17	V
VBx	VB1-U, VB2-V, VB3-W	17	V
VSx	Voltage to VSS	-25 ... 600	V
$V_{in}$	HINx-VSS, LINx-VSS, /ERRIN-VSS	VSS-0.3 ... VCC+0.3	V
$V_{oErr}$	/ERROUT-VSS	VSS-0.3 ... VCC+0.3	V
$I_{max(EO)}$	/ERROUT-VSS	10	mA
$V_{ITRIP}$	ITRIP-VSS	VSS-0.3 ... VCC+0.3	V
<b>Module</b>			
$T_c$		-40 ... 125	$^\circ\text{C}$
$T_{stg}$		-40 ... 125	$^\circ\text{C}$
$V_{isol}$	AC sinus 50Hz, all pins to heat sink, 1 min	2500	V
$I_t(RMS)$	$T_{terminal} = 80^\circ\text{C}$ , 20A per spring	60	A

Characteristics					
Symbol	Conditions	min.	typ.	max.	Unit
<b>Inverter - IGBT</b>					
$V_{CE(sat)}$	$I_C = 30\text{ A}$ $V_{GE} = 15\text{ V}$ chiplevel	$T_j = 25^\circ\text{C}$	1.50	1.90	V
		$T_j = 150^\circ\text{C}$	1.65	2.10	V
$V_{CE0}$	chiplevel	$T_j = 25^\circ\text{C}$	0.9	1	V
		$T_j = 150^\circ\text{C}$	0.85	0.9	V
$r_{CE}$	$V_{GE} = 15\text{ V}$ chiplevel	$T_j = 25^\circ\text{C}$	20	30	m $\Omega$
		$T_j = 150^\circ\text{C}$	27	40	m $\Omega$
$I_{CES}$	$V_{GE} = 0\text{ V}$ $V_{CE} = 600\text{ V}$	$T_j = 25^\circ\text{C}$	0.1	0.3	mA
					mA
$Q_G$	0 V ... +15 V		165		nC
$t_{d(on)}$		$T_j = 150^\circ\text{C}$	855		ns
$t_r$	$V_{CC} = 300\text{ V}$	$T_j = 150^\circ\text{C}$	34		ns
$E_{on}$	$I_C = 30\text{ A}$	$T_j = 150^\circ\text{C}$	1.1		mJ
$t_{d(off)}$	$V_{GE} = +15/0\text{ V}$ <sup>1)</sup>	$T_j = 150^\circ\text{C}$	1273		ns
$t_f$		$T_j = 150^\circ\text{C}$	34		ns
$E_{off}$		$T_j = 150^\circ\text{C}$	1		mJ
$R_{th(j-s)}$	per IGBT		1.4		K/W

# SKiIP 25NABI066V3



MiniSKiIP® CIB IPM

3-phase bridge rectifier +  
brake chopper + 3-phase  
bridge inverter  
intelligent power module

## SKiIP 25NABI066V3

### Features

- Contact springs for solder-free and quick assembly
- Trench-Field-Stop IGBT
- Freewheeling diodes in CAL technology
- HVIC gate driver in SOI technology with advanced level shifter
- Matched propagation delay
- Over-current and under-voltage detection
- Interlock logic for cross conduction protection
- Multi-purpose error input
- Integrated temperature sensor (NTC)
- RoHs compliant
- UL recognised file no. E63532

### Typical Applications\*

- Industrial & consumer drives
- Power supplies (SMPS & UPS)

### Remarks

- Product reliability results valid for  $T_j \leq 150^\circ\text{C}$
- Case temp. limited to  $T_c = 125^\circ\text{C}$  max. (for baseplateless modules  $T_c = T_s$ )

### Footnotes

- <sup>1)</sup> Please refer to Technical Explanations

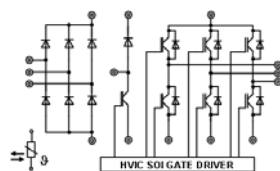

NABI

Characteristics						
Symbol	Conditions		min.	typ.	max.	Unit
<b>Chopper - IGBT</b>						
$V_{CE(sat)}$	$I_C = 30\text{ A}$ $V_{GE} = 15\text{ V}$ chipelevel	$T_j = 25^\circ\text{C}$		1.50	1.90	V
		$T_j = 150^\circ\text{C}$		1.65	2.10	V
$V_{CE0}$	chipelevel	$T_j = 25^\circ\text{C}$		0.9	1	V
		$T_j = 150^\circ\text{C}$		0.85	0.9	V
$r_{CE}$	$V_{GE} = 15\text{ V}$ chipelevel	$T_j = 25^\circ\text{C}$		20	30	m $\Omega$
		$T_j = 150^\circ\text{C}$		27	40	m $\Omega$
$I_{CES}$	$V_{GE} = 0\text{ V}$ $V_{CE} = 600\text{ V}$	$T_j = 25^\circ\text{C}$		0.1	0.3	mA
						mA
$t_{d(on)}$		$T_j = 150^\circ\text{C}$		855		ns
$t_r$	$V_{CC} = 300\text{ V}$	$T_j = 150^\circ\text{C}$		34		ns
$E_{on}$	$I_C = 30\text{ A}$	$T_j = 150^\circ\text{C}$		1.1		mJ
$t_{d(off)}$	$V_{GE} = +15/0\text{ V}$ <sup>1)</sup>	$T_j = 150^\circ\text{C}$		1273		ns
$t_f$		$T_j = 150^\circ\text{C}$		34		ns
$E_{off}$		$T_j = 150^\circ\text{C}$		1		mJ
$R_{th(j-s)}$	per IGBT			1.4		K/W
<b>Inverse diode</b>						
$V_F = V_{EC}$	$I_F = 30\text{ A}$ $V_{GE} = 0\text{ V}$ chipelevel	$T_j = 25^\circ\text{C}$		1.6	1.9	V
		$T_j = 150^\circ\text{C}$		1.7	2.0	V
$V_{F0}$	chipelevel	$T_j = 25^\circ\text{C}$		1	1.1	V
		$T_j = 150^\circ\text{C}$		0.85	0.95	V
$r_F$	chipelevel	$T_j = 25^\circ\text{C}$		21	26	m $\Omega$
		$T_j = 150^\circ\text{C}$		29	34	m $\Omega$
$I_{RRM}$	$I_F = 30\text{ A}$	$T_j = 150^\circ\text{C}$		43		A
$Q_{rr}$	$V_{GE} = 0\text{ V}$	$T_j = 150^\circ\text{C}$		3.4		$\mu\text{C}$
$E_{rr}$	$V_{CC} = 300\text{ V}$	$T_j = 150^\circ\text{C}$		0.7		mJ
$R_{th(j-s)}$	per Diode			1.8		K/W
<b>Freewheeling - Diode</b>						
$V_F = V_{EC}$	$I_F = 30\text{ A}$ $V_{GE} = 0\text{ V}$ chipelevel	$T_j = 25^\circ\text{C}$		1.6	1.9	V
		$T_j = 150^\circ\text{C}$		1.7	2.0	V
$V_{F0}$	chipelevel	$T_j = 25^\circ\text{C}$		1	1.1	V
		$T_j = 150^\circ\text{C}$		0.85	0.95	V
$r_F$	chipelevel	$T_j = 25^\circ\text{C}$		21	26	m $\Omega$
		$T_j = 150^\circ\text{C}$		29	34	m $\Omega$
$I_{RRM}$	$I_F = 30\text{ A}$	$T_j = 150^\circ\text{C}$		43		A
$Q_{rr}$	$V_{GE} = 0\text{ V}$	$T_j = 150^\circ\text{C}$		3.4		$\mu\text{C}$
$E_{rr}$	$V_{CC} = 300\text{ V}$	$T_j = 150^\circ\text{C}$		0.7		mJ
$R_{th(j-s)}$	per Diode			1.8		K/W
<b>Rectifier diode</b>						
$V_F = V_{EC}$	$I_F = 13\text{ A}$ $V_{GE} = 0\text{ V}$ chipelevel	$T_j = 25^\circ\text{C}$		1	1.21	V
		$T_j = 125^\circ\text{C}$			1.1	V
$V_{F0}$	chipelevel	$T_j = 25^\circ\text{C}$			1.0	V
		$T_j = 125^\circ\text{C}$			0.8	V
$r_F$	chipelevel	$T_j = 25^\circ\text{C}$		9.2	18	m $\Omega$
		$T_j = 125^\circ\text{C}$			21	m $\Omega$
$R_{th(j-s)}$	per Diode			1.7		K/W



MiniSKiIP® CIB IPM

3-phase bridge rectifier +  
brake chopper + 3-phase  
bridge inverter

intelligent power module

## SKiIP 25NABI066V3

### Features

- Contact springs for solder-free and quick assembly
- Trench-Field-Stop IGBT
- Freewheeling diodes in CAL technology
- HVIC gate driver in SOI technology with advanced level shifter
- Matched propagation delay
- Over-current and under-voltage detection
- Interlock logic for cross conduction protection
- Multi-purpose error input
- Integrated temperature sensor (NTC)
- RoHs compliant
- UL recognised file no. E63532

### Typical Applications\*

- Industrial & consumer drives
- Power supplies (SMPS & UPS)

### Remarks

- Product reliability results valid for  $T_j \leq 150^\circ\text{C}$
- Case temp. limited to  $T_c = 125^\circ\text{C}$  max. (for baseplateless modules  $T_c = T_s$ )

### Footnotes

<sup>1)</sup> Please refer to Technical Explanations

Characteristics					
Symbol	Conditions	min.	typ.	max.	Unit
<b>Driver</b>					
VCC	VCC-VSS, VCCL-VSSL <sup>1)</sup>		15		V
ICCo	Quiescent current, VCC=15V <sup>1)</sup>			6.5	mA
VBx	VB1-U, VB2-V, VB2-W <sup>1)</sup>		15		V
IBx	Quiescent high side driver supply current per channel, VBx=15V <sup>1)</sup>		380	450	µA
V <sub>IT+</sub>	Input threshold voltage (HIGH) <sup>1)</sup>		1.9	2.4	V
V <sub>IT-</sub>	Input threshold voltage (LOW) <sup>1)</sup>	0.8	1.1		V
V <sub>ITRIP+</sub>	ITRIP set threshold voltage <sup>1)</sup>		0.51	0.6	V
V <sub>ITRIP-</sub>	ITRIP reset threshold voltage <sup>1)</sup>	0.35	0.41		V
V <sub>oErr</sub>	Error output, open drain <sup>1)</sup>			15	V
V <sub>UV</sub>	Supply under-voltage protection set <sup>1)</sup>	10.5	11.1		V
V <sub>UVr</sub>	Supply under-voltage protection reset <sup>1)</sup>		11.5	12.3	V
t <sub>d,ITRIP</sub>	ITRIP to LOUTx/HOUTx shutdown propagation delay		700		ns
t <sub>SIS</sub>	PWM short pulse suppression		0.47		µs
t <sub>TD</sub>	Interlock dead time		0.48		µs
f <sub>SW</sub>	Switching frequency			25	kHz
<b>Temperatur Sensor</b>					
R <sub>25</sub>	T <sub>r</sub> = 25 °C <sup>1)</sup>		5.0 ± 5%		kΩ
<b>Module</b>					
M <sub>s</sub>	to heat sink	2		2.5	Nm
w	weight		60		g

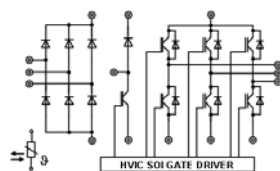

NABI

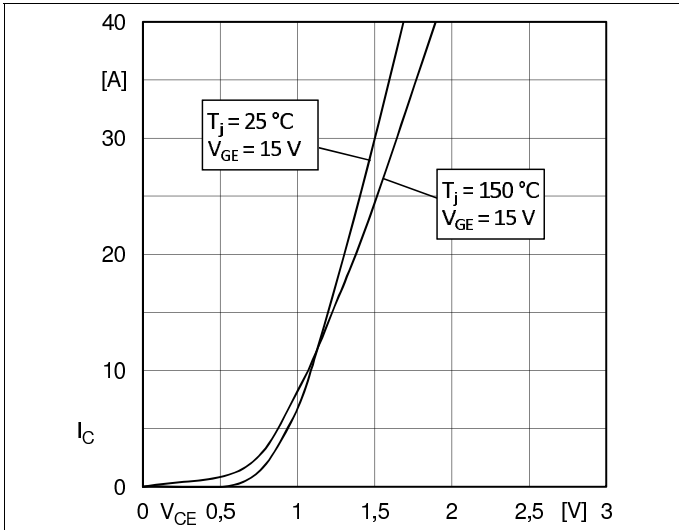

Fig. 1: Typ. output characteristic

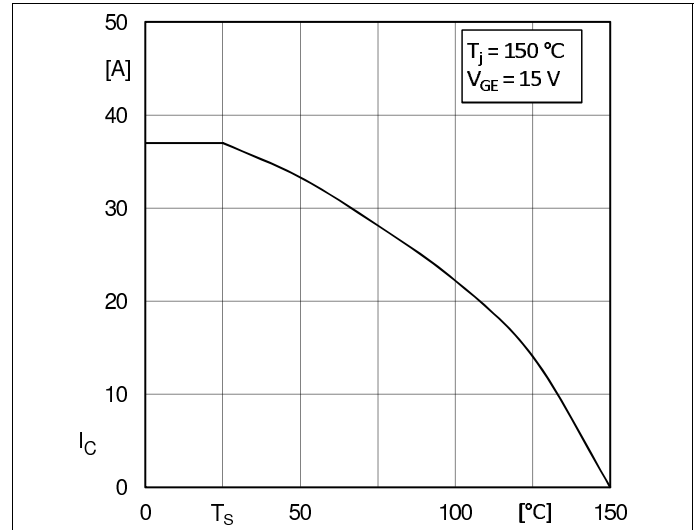

Fig. 2: Typ. rated current vs. temperature  $I_C = f(T_s)$

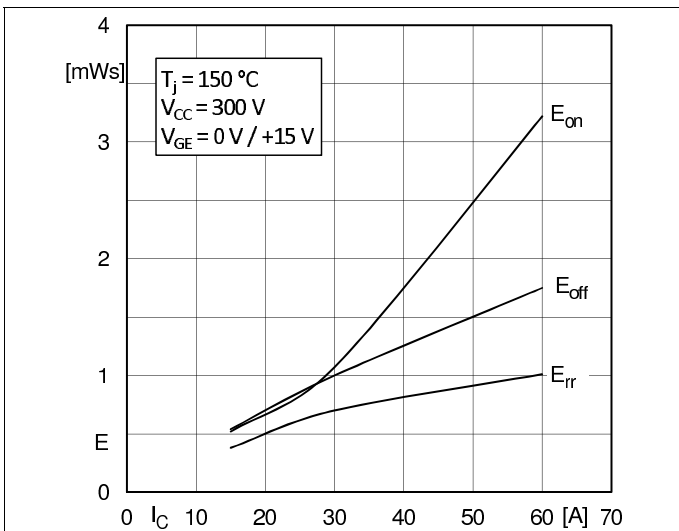

Fig. 3: Typ. turn-on /-off energy =  $f(I_C)$

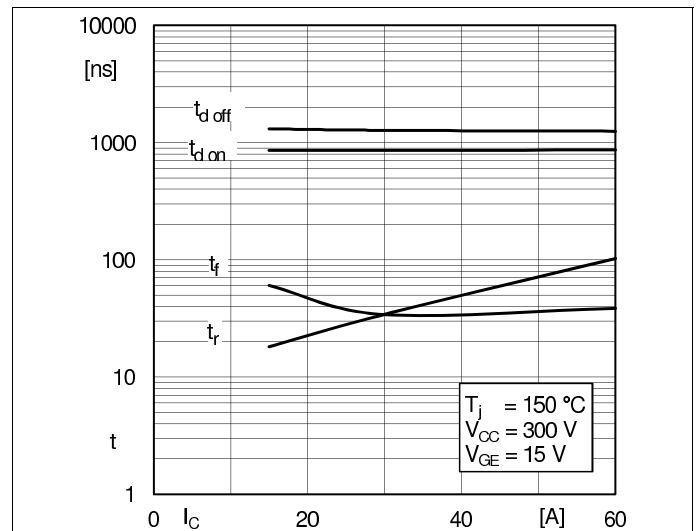

Fig. 4: Typ. switching times vs.  $I_C$

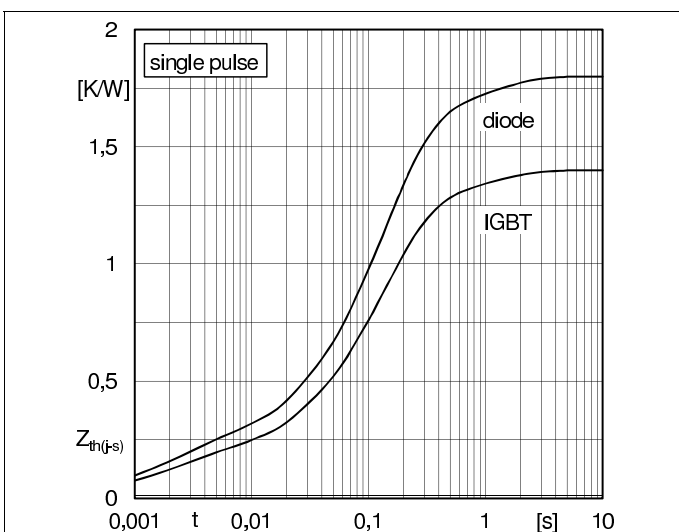

Fig. 5: Transient thermal impedance of IGBT and diode

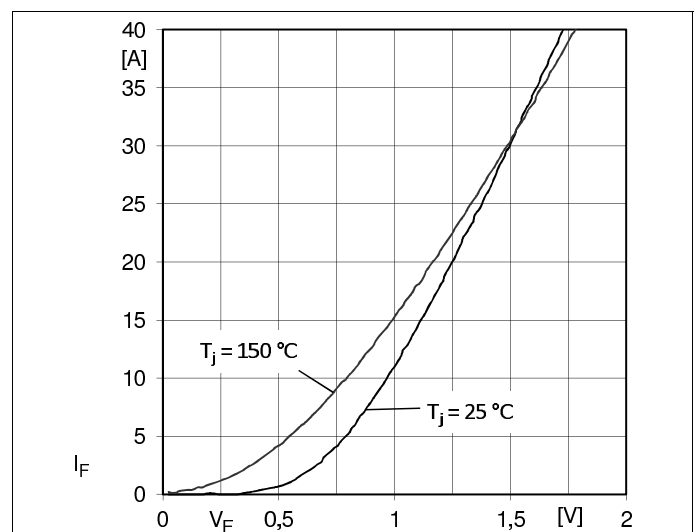

Fig. 6: Typ. freewheeling diode forward characteristic

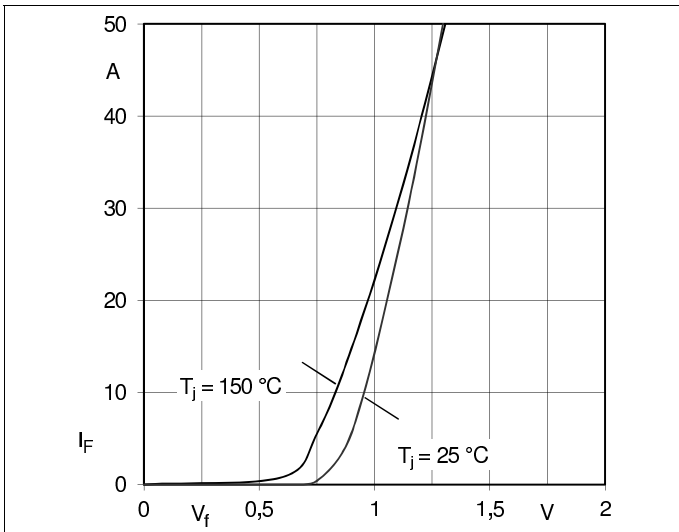
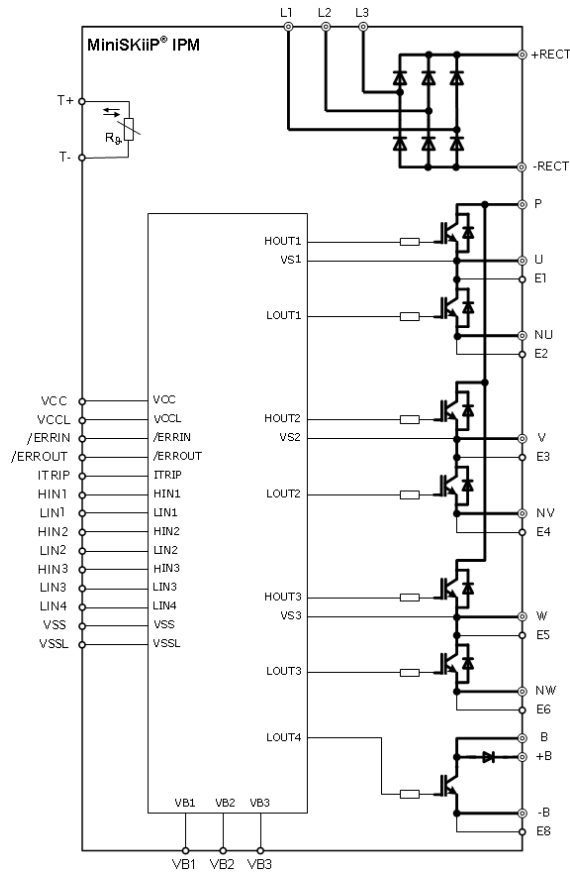

Fig. 7: Typ. input bridge forward characteristic



Internal circuit

Pin	Signal	Description
1	HIN1	PWM signal input for phase U high side switch
2	HIN2	PWM signal input for phase V high side switch
3	HIN3	PWM signal input for phase W high side switch
4	LIN1	PWM signal input for phase U low side switch
5	LIN2	PWM signal input for phase V low side switch
6	LIN3	PWM signal input for phase W low side switch
7	/ERROUT	Error logic output (low active)
8	/ERRIN	Multi-purpose error input for common shut-down (low active)
9	ITRIP	Comparator input / current sense input for overcurrent shut-down
10	LIN4	PWM signal input for brake chopper switch
11	VSS	Driver IC supply voltage ground
12	VCC	Driver IC main supply voltage
13	VB2	Floating supply voltage for phase V high side IGBT
14	VB1	Floating supply voltage for phase U high side IGBT
15	VB3	Floating supply voltage for phase W high side IGBT
16	VSSL	Low side supply voltage ground
17	VCCCL	Low side supply voltage
L1	L1	Bridge rectifier input for phase 1
L2	L2	Bridge rectifier input for phase 2
L3	L3	Bridge rectifier input for phase 3
U	U	Phase U AC terminal
E1	E1	Auxiliary emitter terminal of phase U high side IGBT
V	V	Phase V AC terminal
E3	E3	Auxiliary emitter terminal of phase V high side IGBT
W	W	Phase W AC terminal
E5	E5	Auxiliary emitter terminal of phase W high side IGBT
NU	NU	Phase U -DC terminal
E2	E2	Auxiliary emitter terminal of phase U low side IGBT
NV	NV	Phase V -DC terminal
E4	E4	Auxiliary emitter terminal of phase V low side IGBT
NW	NW	Phase W -DC terminal
E6	E6	Auxiliary emitter terminal of phase W low side IGBT
B	B	Brake chopper B terminal
+B	+B	Brake chopper +B terminal
-B	-B	Brake chopper -B terminal
E8	E8	Auxiliary emitter terminal of brake chopper IGBT
P	P	+DC terminal
+RECT	+RECT	Bridge rectifier positive voltage output terminal
-RECT	-RECT	Bridge rectifier negative voltage output terminal
+T	+T	Temperature sensor terminal (+)
-T	-T	Temperature sensor terminal (-)

Pin and signal description

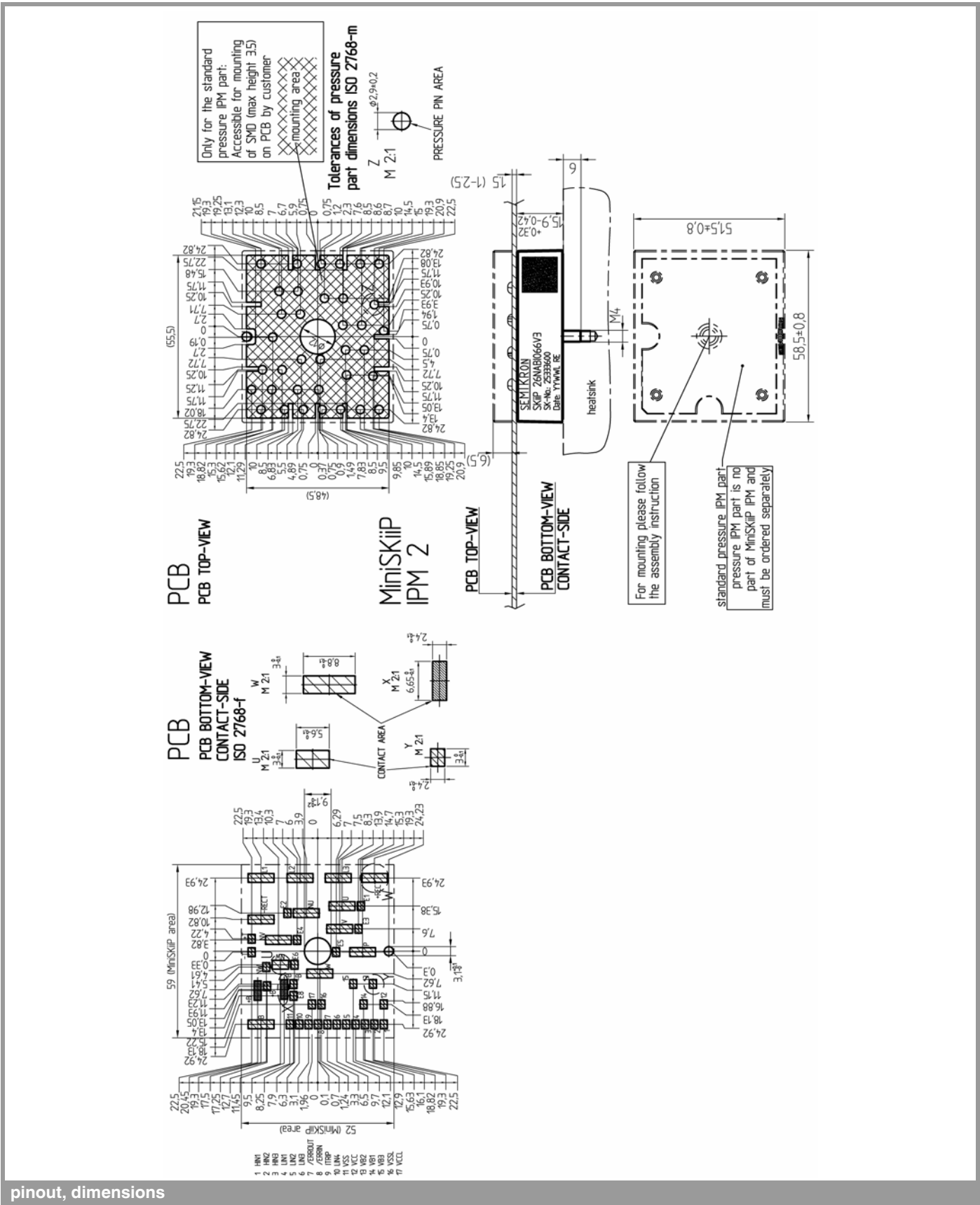

This is an electrostatic discharge sensitive device (ESDS), international standard IEC 60747-1, Chapter IX

\* The specifications of our components may not be considered as an assurance of component characteristics. Components have to be tested for the respective application. Adjustments may be necessary. The use of SEMIKRON products in life support appliances and systems is subject to prior specification and written approval by SEMIKRON. We therefore strongly recommend prior consultation of our staff.