

SKiiP 39AC12T4V1

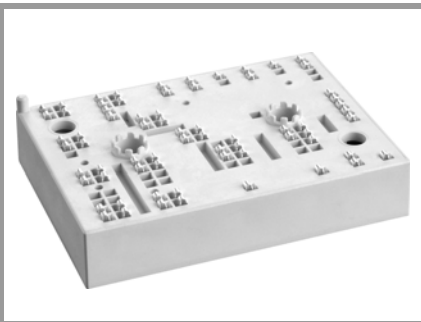

MiniSKiiP® 3

SKiiP 39AC12T4V1

Features

- Trench 4 IGBT's
- Robust and soft freewheeling diodes in CAL technology
- Highly reliable spring contacts for electrical connections
- UL recognised file no. E63532

Typical Applications*

- Inverter up to 50 kVA
- Typical motor power 30 kW

Remarks

- V_{CEsat} , V_F = chip level value
- Case temp. limited to $T_C = 125^\circ\text{C}$ max. (for baseplateless modules $T_C = T_S$)
- product rel. results valid for $T_j \leq 150$ (recomm. $T_{op} = -40 \dots +150^\circ\text{C}$)
- For short circuit: Soft R_{Goff} recommended

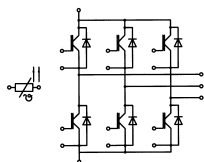

AC

Absolute Maximum Ratings			
Symbol	Conditions	Values	Unit
Inverter - IGBT			
V_{CES}	$T_j = 25^\circ\text{C}$	1200	V
I_C	$T_j = 175^\circ\text{C}$	$T_s = 25^\circ\text{C}$	167
		$T_s = 70^\circ\text{C}$	135
I_{Cnom}		150	A
I_{CRM}	$I_{CRM} = 3 \times I_{Cnom}$	450	A
V_{GES}		-20 ... 20	V
t_{psc}	$V_{CC} = 800\text{ V}$	$T_j = 150^\circ\text{C}$	10
	$V_{GE} \leq 15\text{ V}$		
	$V_{CES} \leq 1200\text{ V}$		μs
T_j		-40 ... 175	$^\circ\text{C}$
Inverse - Diode			
I_F	$T_j = 175^\circ\text{C}$	$T_s = 25^\circ\text{C}$	136
		$T_s = 70^\circ\text{C}$	107
I_{Fnom}		150	A
I_{FRM}	$I_{FRM} = 3 \times I_{Fnom}$	450	A
I_{FSM}	10 ms, sin 180°, $T_j = 150^\circ\text{C}$	900	A
T_j		-40 ... 175	$^\circ\text{C}$
Module			
$I_{t(RMS)}$	$T_{terminal} = 80^\circ\text{C}$, 20A per spring	160	A
T_{stg}		-40 ... 125	$^\circ\text{C}$
V_{isol}	AC sinus 50Hz, t = 1 min	2500	V

Characteristics					
Symbol	Conditions	min.	typ.	max.	Unit
Inverter - IGBT					
$V_{CE(sat)}$	$I_C = 150\text{ A}$ $V_{GE} = 15\text{ V}$ chipllevel	$T_j = 25^\circ\text{C}$	1.85	2.10	V
		$T_j = 150^\circ\text{C}$	2.25	2.45	V
V_{CE0}		$T_j = 25^\circ\text{C}$	0.8	0.9	V
		$T_j = 150^\circ\text{C}$	0.7	0.8	V
r_{CE}	$V_{GE} = 15\text{ V}$	$T_j = 25^\circ\text{C}$	7.0	8.0	m Ω
		$T_j = 150^\circ\text{C}$	10	11	m Ω
$V_{GE(th)}$	$V_{GE} = V_{CE}$, $I_C = 6\text{ mA}$	5	5.8	6.5	V
I_{CES}	$V_{GE} = 0\text{ V}$ $V_{CE} = 1200\text{ V}$	$T_j = 25^\circ\text{C}$	0.1	0.3	mA
					mA
C_{ies}	$V_{CE} = 25\text{ V}$		8.80		nF
C_{oes}	$V_{GE} = 0\text{ V}$	$f = 1\text{ MHz}$	0.58		nF
C_{res}		$f = 1\text{ MHz}$	0.47		nF
Q_G	- 8 V...+ 15 V		850		nC
R_{Gint}	$T_j = 25^\circ\text{C}$		5.00		Ω
$t_{d(on)}$	$V_{CC} = 600\text{ V}$	$T_j = 150^\circ\text{C}$	165		ns
t_r	$I_C = 150\text{ A}$ $R_{Gon} = 1\ \Omega$	$T_j = 150^\circ\text{C}$	50		ns
		$T_j = 150^\circ\text{C}$	22.5		mJ
E_{on}	$R_{Goff} = 1\ \Omega$	$T_j = 150^\circ\text{C}$			mJ
$t_{d(off)}$	$di/dt_{on} = 2840\text{ A}/\mu\text{s}$	$T_j = 150^\circ\text{C}$	390		ns
t_f	$di/dt_{off} = 1880\text{ A}/\mu\text{s}$	$T_j = 150^\circ\text{C}$	80		ns
E_{off}	$V_{GE} = +15/-15\text{ V}$	$T_j = 150^\circ\text{C}$	14		mJ
$R_{th(j-s)}$	per IGBT		0.33		K/W

SKiiP 39AC12T4V1

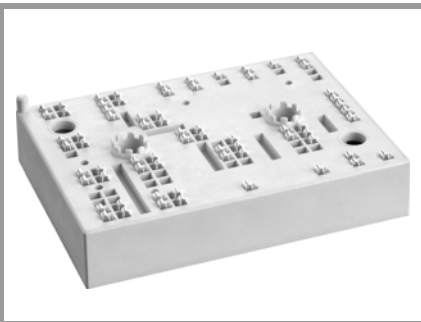

MiniSKiiP® 3

SKiiP 39AC12T4V1

Features

- Trench 4 IGBT's
- Robust and soft freewheeling diodes in CAL technology
- Highly reliable spring contacts for electrical connections
- UL recognised file no. E63532

Typical Applications*

- Inverter up to 50 kVA
- Typical motor power 30 kW

Remarks

- V_{CEsat} , V_F = chip level value
- Case temp. limited to $T_C = 125^\circ\text{C}$ max. (for baseplateless modules $T_C = T_S$)
- product rel. results valid for $T_j \leq 150$ (recomm. $T_{op} = -40 \dots +150^\circ\text{C}$)
- For short circuit: Soft R_{Goff} recommended

Characteristics						
Symbol	Conditions		min.	typ.	max.	Unit
Inverse - Diode						
$V_F = V_{EC}$	$I_F = 150 \text{ A}$ $V_{GE} = 0 \text{ V}$ chiplevel	$T_j = 25^\circ\text{C}$		2.1	2.5	V
		$T_j = 150^\circ\text{C}$		2.1	2.4	V
V_{F0}		$T_j = 25^\circ\text{C}$		1.3	1.5	V
		$T_j = 150^\circ\text{C}$		0.9	1.1	V
r_F		$T_j = 25^\circ\text{C}$		5.6	6.4	m Ω
		$T_j = 150^\circ\text{C}$		7.8	8.5	m Ω
I_{RRM}	$I_F = 150 \text{ A}$	$T_j = 150^\circ\text{C}$		188		A
Q_{rr}	$di/dt_{off} = 4020 \text{ A}/\mu\text{s}$	$T_j = 150^\circ\text{C}$		27		μC
E_{rr}	$V_{GE} = -15 \text{ V}$ $V_{CC} = 600 \text{ V}$	$T_j = 150^\circ\text{C}$		11.4		mJ
$R_{th(j-s)}$	per Diode			0.52		K/W
Module						
M_s	to heat sink		2		2.5	Nm
w				95		g
Temperatur Sensor						
R_{100}	$T_C = 100^\circ\text{C}$ ($R_{25} = 1000\Omega$)			1670 \pm 3%		Ω
$R(T)$	$R(T) = 1000\Omega [1 + A(T - 25^\circ\text{C}) + B(T - 25^\circ\text{C})^2]$], $A = 7.635 \cdot 10^{-3} \text{ }^\circ\text{C}^{-1}$, $B = 1.731 \cdot 10^{-5} \text{ }^\circ\text{C}^{-2}$					

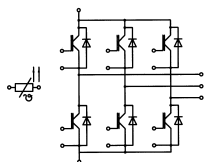

AC

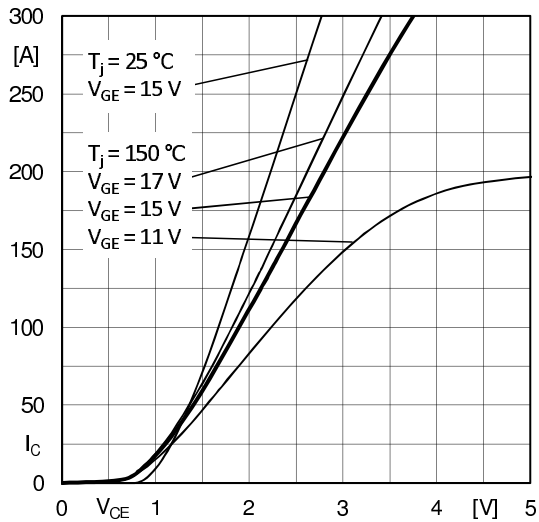

Fig. 1: Typ. output characteristic, inclusive $R_{CC'+EE'}$

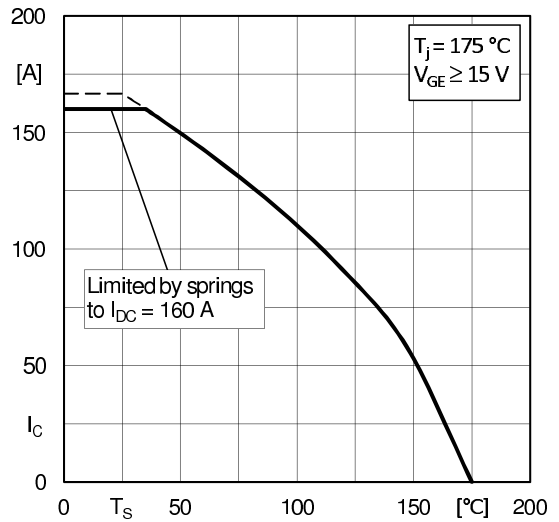

Fig. 2: Rated current vs. temperature $I_C = f(T_S)$

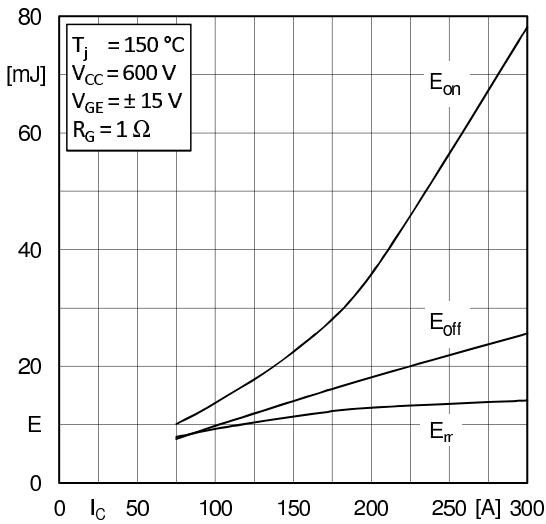

Fig. 3: Typ. turn-on /-off energy = $f(I_C)$

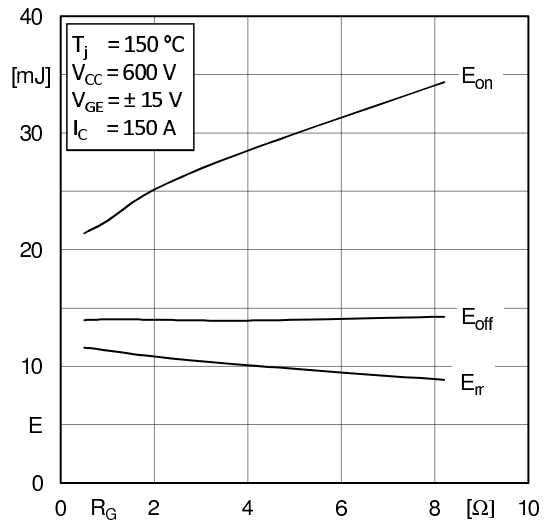

Fig. 4: Typ. turn-on /-off energy = $f(R_G)$

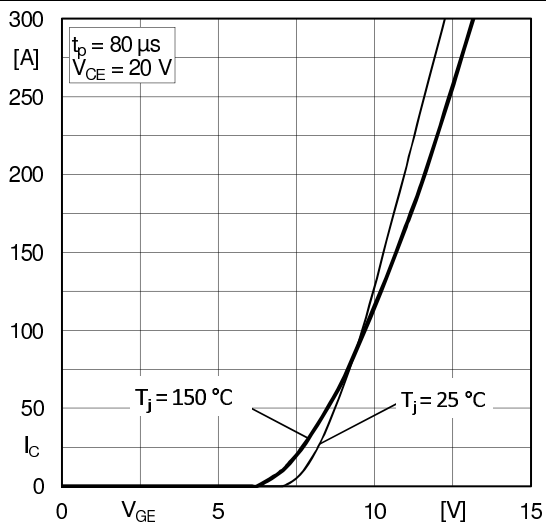

Fig. 5: Typ. transfer characteristic

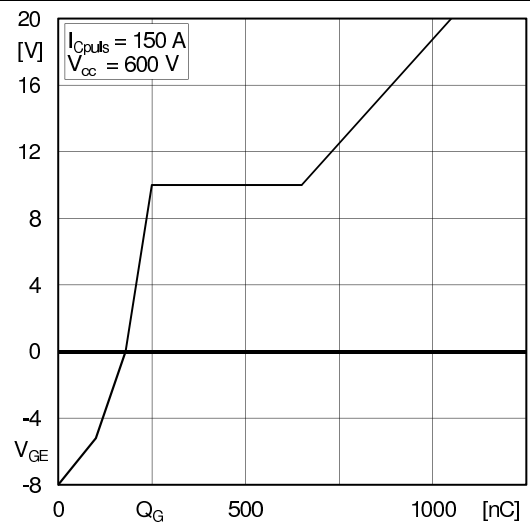

Fig. 6: Typ. gate charge characteristic

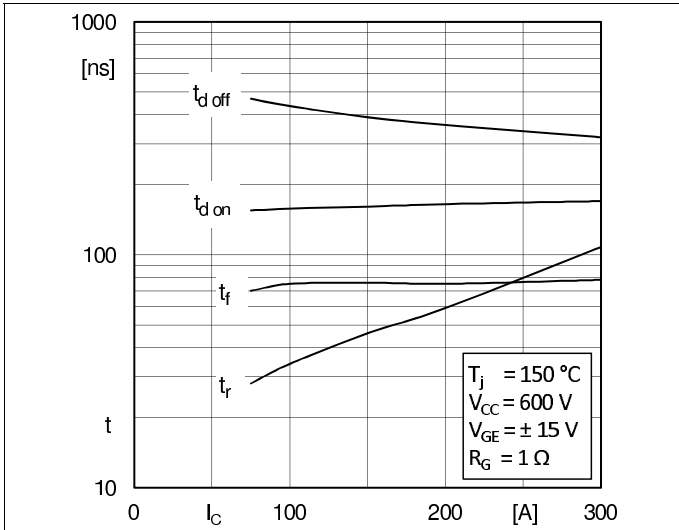

Fig. 7: Typ. switching times vs. I_c

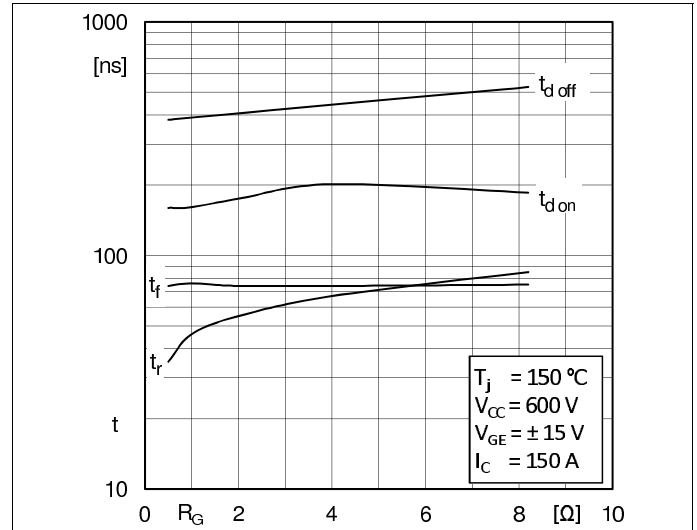

Fig. 8: Typ. switching times vs. gate resistor R_G

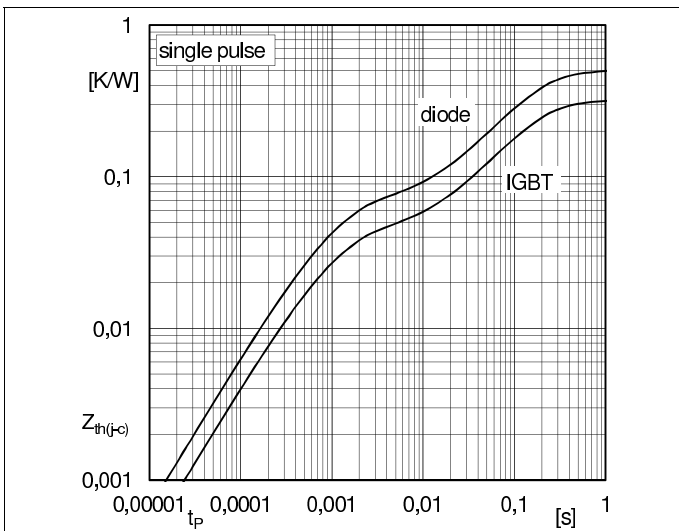

Fig. 9: Transient thermal impedance of IGBT and Diode

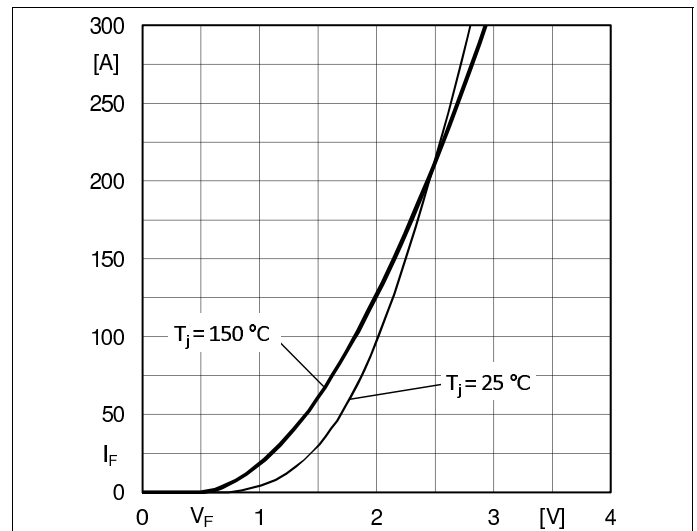

Fig. 10: CAL diode forward characteristic

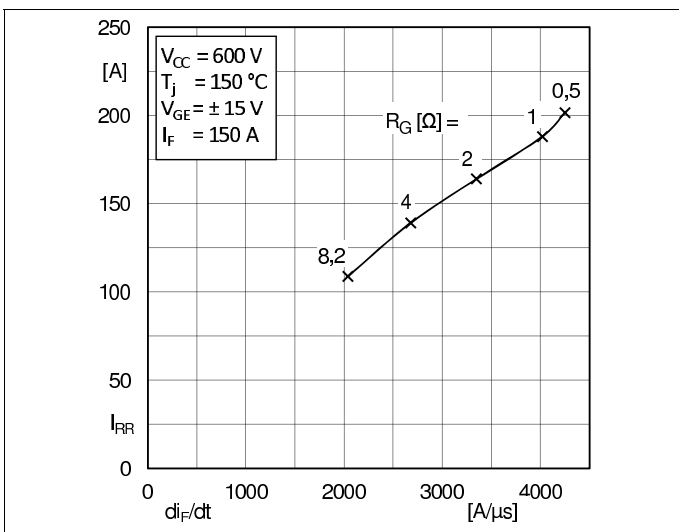

Fig. 11: Typ. CAL diode peak reverse recovery current

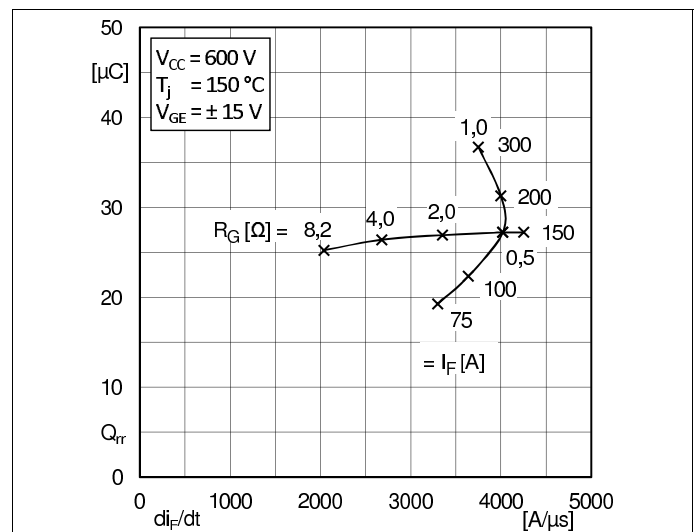
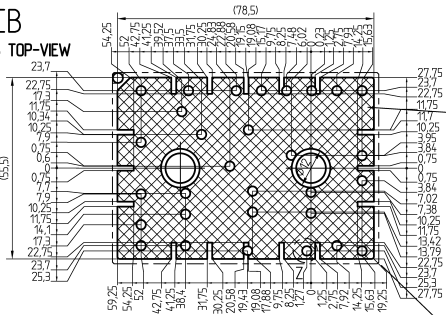

Fig. 12: Typ. CAL diode recovery charge

SKiiP 39AC12T4V1

PCB
PCB TOP-VIEW



Only for the standard pressure part:
Accessible for mounting of SMD (max height 35) on PCB by customer

MiniSKiiP 3

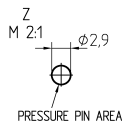
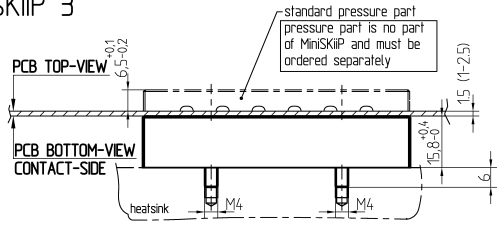

PCB TOP-VIEW
PCB BOTTOM-VIEW CONTACT-SIDE

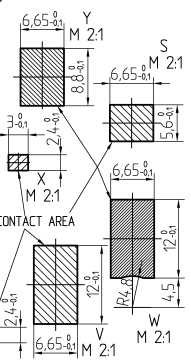
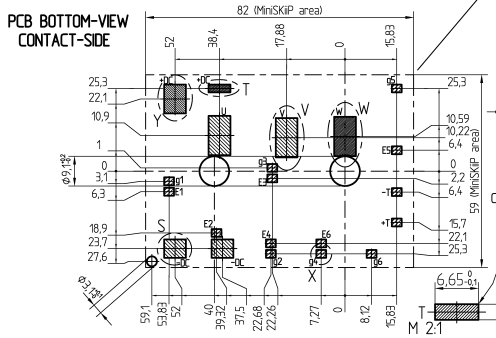

For mounting please follow the assembly instruction

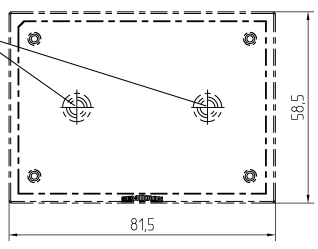

measure: mm
tolerance: ISO 2768-f

These documents are Semikron property. Semikron reserves all copyrights. All copying and transmitting of this information requires written permission. For the case of industrial property rights, Semikron reserves all rights.

pinout, dimensions

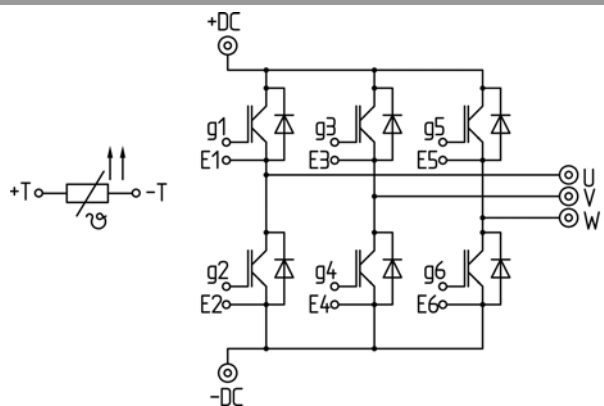

⊙ power connector
◦ control connector

pinout

This is an electrostatic discharge sensitive device (ESDS), international standard IEC 60747-1, Chapter IX

* The specifications of our components may not be considered as an assurance of component characteristics. Components have to be tested for the respective application. Adjustments may be necessary. The use of SEMIKRON products in life support appliances and systems is subject to prior specification and written approval by SEMIKRON. We therefore strongly recommend prior consultation of our staff.