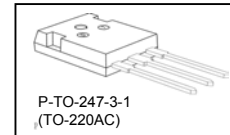
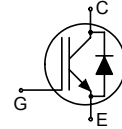


Low Loss DuoPack : IGBT in Trench and Fieldstop technology  
with soft, fast recovery anti-parallel EmCon HE diode

- Very low  $V_{CE(sat)}$  1.5 V (typ.)
- Maximum Junction Temperature 175 °C
- Short circuit withstand time – 5 $\mu$ s
- Designed for :
  - Frequency Converters
  - Uninterruptible Power Supply
- Trench and Fieldstop technology for 600 V applications offers :
  - very tight parameter distribution
  - high ruggedness, temperature stable behavior
  - very high switching speed
  - low  $V_{CE(sat)}$
- Positive temperature coefficient in  $V_{CE(sat)}$
- Low EMI
- Low Gate Charge
- Very soft, fast recovery anti-parallel EmCon HE diode
- Complete product spectrum and PSpice Models : <http://www.infineon.com/igbt/>



| Type      | $V_{CE}$ | $I_C$ | $V_{CE(sat), T_j=25^\circ C}$ | $T_{j,max}$ | Marking Code | Package | Ordering Code |
|-----------|----------|-------|-------------------------------|-------------|--------------|---------|---------------|
| IKW30N60T | 600V     | 30A   | 1.5V                          | 175°C       | K30T60       | TO-247  | Q67040S4717   |

### Maximum Ratings

| Parameter   | Symbol      | Value      | Unit    |
|---|-------------|------------|---------|
| Collector-emitter voltage   | $V_{CE}$    | 600        | V       |
| DC collector current, limited by $T_{j,max}$                              | $I_C$       |            | A       |
| $T_C = 25^\circ C$  |             | 60         |         |
| $T_C = 100^\circ C$   |             | 30         |         |
| Pulsed collector current, $t_p$ limited by $T_{j,max}$                    | $I_{Cpuls}$ | 90         |         |
| Turn off safe operating area ( $V_{CE} \leq 600V, T_j \leq 175^\circ C$ ) | -           | 90         |         |
| Diode forward current, limited by $T_{j,max}$                             | $I_F$       |            |         |
| $T_C = 25^\circ C$  |             | 60         |         |
| $T_C = 100^\circ C$   |             | 30         |         |
| Diode pulsed current, $t_p$ limited by $T_{j,max}$                        | $I_{Fpuls}$ | 90         |         |
| Gate-emitter voltage  | $V_{GE}$    | $\pm 20$   | V       |
| Short circuit withstand time <sup>1)</sup>                                | $t_{SC}$    | 5          | $\mu$ s |
| $V_{GE} = 15V, V_{CC} \leq 400V, T_j \leq 150^\circ C$                    |             |            |         |
| Power dissipation $T_C = 25^\circ C$                                      | $P_{tot}$   | 187        | W       |
| Operating junction temperature  | $T_j$       | -40...+175 | °C      |
| Storage temperature   | $T_{stg}$   | -55...+175 |         |
| Soldering temperature, 1.6mm (0.063 in.) from case for 10s                | -           | 260        |         |

<sup>1)</sup> Allowed number of short circuits: <1000; time between short circuits: >1s.

### Thermal Resistance

| Parameter                                 | Symbol      | Conditions | Max. Value | Unit |
|---|-------------|------------|------------|------|
| <b>Characteristic</b>                     |             |            |            |      |
| IGBT thermal resistance, junction – case  | $R_{thJC}$  | TO-247     | 0.80       | K/W  |
| Diode thermal resistance, junction – case | $R_{thJCD}$ | TO-247     | 1.05       |      |
| Thermal resistance, junction – ambient    | $R_{thJA}$  | TO-247 AC  | 40         |      |

### Electrical Characteristic, at $T_j = 25^\circ\text{C}$ , unless otherwise specified

| Parameter                            | Symbol        | Conditions  | Value |      |      | Unit          |
|--------------------------------------|---------------|---|-------|------|------|---------------|
|                                      |               |   | min.  | typ. | max. |               |
| <b>Static Characteristic</b>         |               |   |       |      |      |               |
| Collector-emitter breakdown voltage  | $V_{(BR)CES}$ | $V_{GE}=0V, I_C=0.2mA$  | 600   | -    | -    | V             |
| Collector-emitter saturation voltage | $V_{CE(sat)}$ | $V_{GE} = 15V, I_C=30A$<br>$T_j=25^\circ\text{C}$<br>$T_j=175^\circ\text{C}$  | -     | 1.5  | 2.05 |               |
|                                      |               |   | -     | 1.9  | -    |               |
| Diode forward voltage                | $V_F$         | $V_{GE}=0V, I_F=30A$<br>$T_j=25^\circ\text{C}$<br>$T_j=175^\circ\text{C}$     | -     | 1.65 | 2.05 |               |
|                                      |               |   | -     | 1.6  | -    |               |
| Gate-emitter threshold voltage       | $V_{GE(th)}$  | $I_C=0.43mA, V_{CE}=V_{GE}$   | 4.1   | 4.9  | 5.7  |               |
| Zero gate voltage collector current  | $I_{CES}$     | $V_{CE}=600V, V_{GE}=0V$<br>$T_j=25^\circ\text{C}$<br>$T_j=175^\circ\text{C}$ | -     | -    | 40   | $\mu\text{A}$ |
|                                      |               |   | -     | -    | 1000 |               |
| Gate-emitter leakage current         | $I_{GES}$     | $V_{CE}=0V, V_{GE}=20V$   | -     | -    | 100  | nA            |
| Transconductance                     | $g_{fs}$      | $V_{CE}=20V, I_C=30A$   | -     | 16.7 | -    | S             |
| Integrated gate resistor             | $R_{Gint}$    |   |       | -    |      | $\Omega$      |

### Dynamic Characteristic

|  |             |   |   |      |   |               |
|--|-------------|---|---|------|---|---------------|
| Input capacitance  | $C_{iss}$   | $V_{CE}=25V, V_{GE}=0V, f=1\text{MHz}$  | - | 1630 | - | $\mu\text{F}$ |
| Output capacitance   | $C_{oss}$   |   | - | 108  | - |               |
| Reverse transfer capacitance                                   | $C_{riss}$  |   | - | 50   | - |               |
| Gate charge  | $Q_{Gate}$  | $V_{CC}=480V, I_C=30A, V_{GE}=15V$  | - | 167  | - | nC            |
| Internal emitter inductance measured 5mm (0.197 in.) from case | $L_E$       | TO-247-3-1  | - | 7    | - | nH            |
| Short circuit collector current <sup>1)</sup>                  | $I_{C(SC)}$ | $V_{GE}=15V, t_{SC}\leq 5\mu\text{s}$<br>$V_{CC}=400V, T_j=150^\circ\text{C}$ | - | 275  | - | A             |

<sup>1)</sup> Allowed number of short circuits: <1000; time between short circuits: >1s.

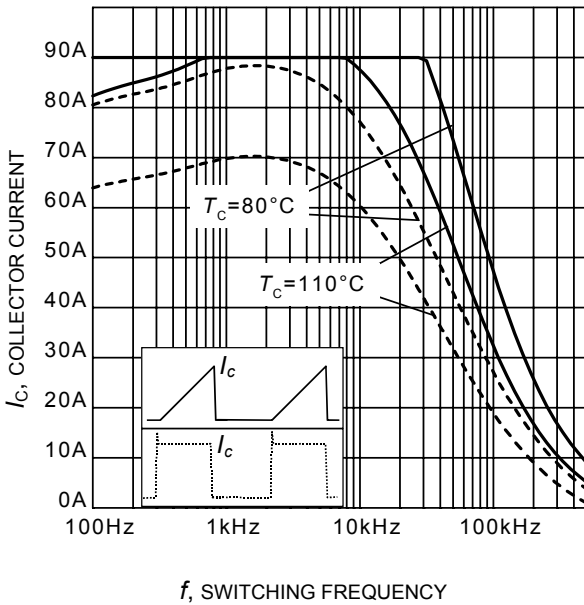
### Switching Characteristic, Inductive Load, at $T_j=25^\circ\text{C}$

| Parameter  | Symbol       | Conditions  | Value |      |      | Unit                   |
|--|--------------|---|-------|------|------|------------------------|
|  |              |   | min.  | Typ. | max. |                        |
| <b>IGBT Characteristic</b>                                       |              |   |       |      |      |                        |
| Turn-on delay time   | $t_{d(on)}$  | $T_j=25^\circ\text{C}$ ,<br>$V_{CC}=400\text{V}$ , $I_C=30\text{A}$ ,<br>$V_{GE}=0/15\text{V}$ ,<br>$R_G=10.6\ \Omega$ ,<br>$L_{\sigma}^{1)}=136\text{nH}$ ,<br>$C_{\sigma}^{1)}=39\text{pF}$<br>Energy losses include<br>"tail" and diode<br>reverse recovery. | -     | 23   | -    | ns                     |
| Rise time  | $t_r$        |   | -     | 21   | -    |                        |
| Turn-off delay time  | $t_{d(off)}$ |   | -     | 254  | -    |                        |
| Fall time  | $t_f$        |   | -     | 46   | -    |                        |
| Turn-on energy   | $E_{on}$     |   | -     | 0.69 | -    | mJ                     |
| Turn-off energy  | $E_{off}$    |   | -     | 0.77 | -    |                        |
| Total switching energy   | $E_{ts}$     |   | -     | 1.46 | -    |                        |
| <b>Anti-Parallel Diode Characteristic</b>                        |              |   |       |      |      |                        |
| Diode reverse recovery time                                      | $t_{rr}$     | $T_j=25^\circ\text{C}$ ,<br>$V_R=400\text{V}$ , $I_F=30\text{A}$ ,<br>$di_F/dt=910\text{A}/\mu\text{s}$   | -     | 143  | -    | ns                     |
| Diode reverse recovery charge                                    | $Q_{rr}$     |   | -     | 0.92 | -    | $\mu\text{C}$          |
| Diode peak reverse recovery current                              | $I_{rrm}$    |   | -     | 16.3 | -    | A                      |
| Diode peak rate of fall of reverse recovery current during $t_b$ | $di_{rr}/dt$ |   | -     | 603  | -    | $\text{A}/\mu\text{s}$ |

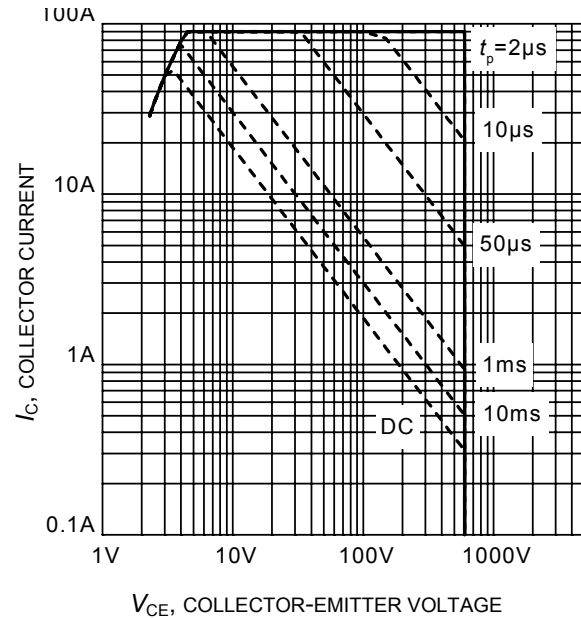
### Switching Characteristic, Inductive Load, at $T_j=175^\circ\text{C}$

| Parameter  | Symbol       | Conditions   | Value |      |      | Unit                   |
|--|--------------|--|-------|------|------|------------------------|
|  |              |  | min.  | Typ. | max. |                        |
| <b>IGBT Characteristic</b>                                       |              |  |       |      |      |                        |
| Turn-on delay time   | $t_{d(on)}$  | $T_j=175^\circ\text{C}$ ,<br>$V_{CC}=400\text{V}$ , $I_C=30\text{A}$ ,<br>$V_{GE}=0/15\text{V}$ ,<br>$R_G=10.6\ \Omega$ ,<br>$L_{\sigma}^{1)}=136\text{nH}$ ,<br>$C_{\sigma}^{1)}=39\text{pF}$<br>Energy losses include<br>"tail" and diode<br>reverse recovery. | -     | 24   | -    | ns                     |
| Rise time  | $t_r$        |  | -     | 26   | -    |                        |
| Turn-off delay time  | $t_{d(off)}$ |  | -     | 292  | -    |                        |
| Fall time  | $t_f$        |  | -     | 90   | -    |                        |
| Turn-on energy   | $E_{on}$     |  | -     | 1.0  | -    | mJ                     |
| Turn-off energy  | $E_{off}$    |  | -     | 1.1  | -    |                        |
| Total switching energy   | $E_{ts}$     |  | -     | 2.1  | -    |                        |
| <b>Anti-Parallel Diode Characteristic</b>                        |              |  |       |      |      |                        |
| Diode reverse recovery time                                      | $t_{rr}$     | $T_j=175^\circ\text{C}$ ,<br>$V_R=400\text{V}$ , $I_F=30\text{A}$ ,<br>$di_F/dt=910\text{A}/\mu\text{s}$   | -     | 225  | -    | ns                     |
| Diode reverse recovery charge                                    | $Q_{rr}$     |  | -     | 2.39 | -    | $\mu\text{C}$          |
| Diode peak reverse recovery current                              | $I_{rrm}$    |  | -     | 22.3 | -    | A                      |
| Diode peak rate of fall of reverse recovery current during $t_b$ | $di_{rr}/dt$ |  | -     | 310  | -    | $\text{A}/\mu\text{s}$ |

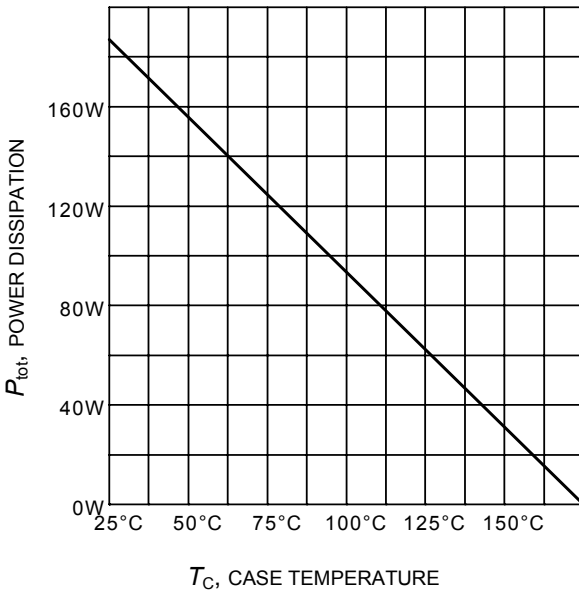
<sup>1)</sup> Leakage inductance  $L_{\sigma}$  and Stray capacity  $C_{\sigma}$  due to dynamic test circuit in Figure E.



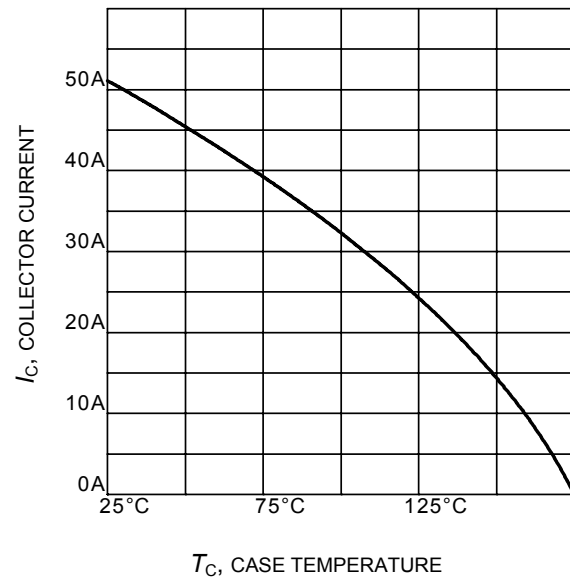
**Figure 1. Collector current as a function of switching frequency**  
 $(T_J \leq 175^\circ\text{C}, D = 0.5, V_{CE} = 400\text{V}, V_{GE} = 0/+15\text{V}, R_G = 10\Omega)$



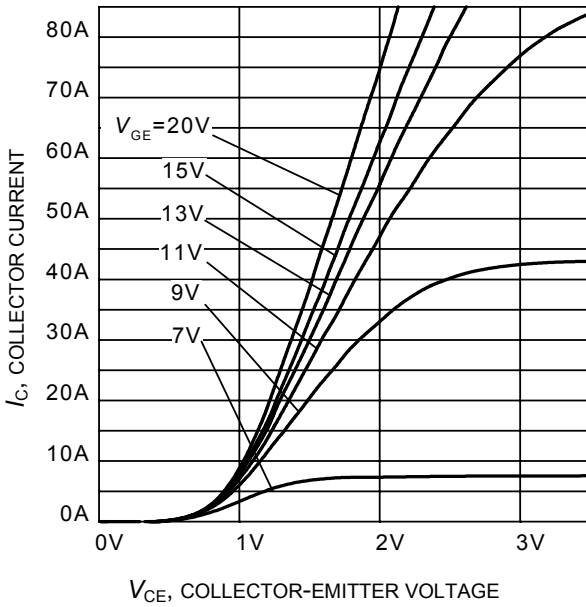
**Figure 2. Safe operating area**  
 $(D = 0, T_C = 25^\circ\text{C}, T_J \leq 175^\circ\text{C}; V_{GE} = 15\text{V})$



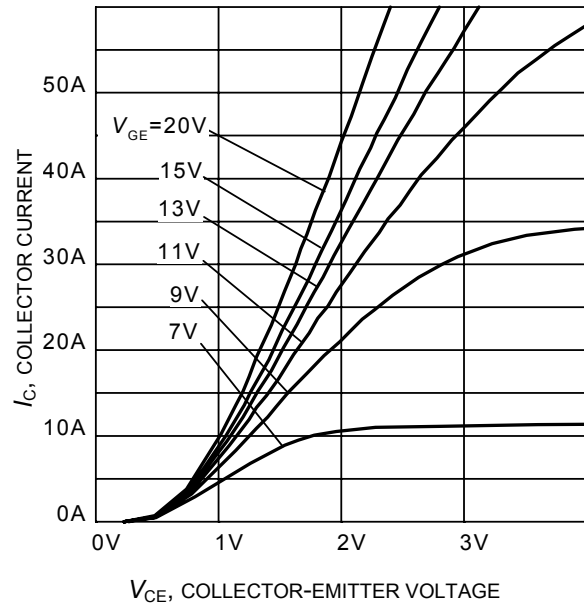
**Figure 3. Power dissipation as a function of case temperature**  
 $(T_J \leq 175^\circ\text{C})$



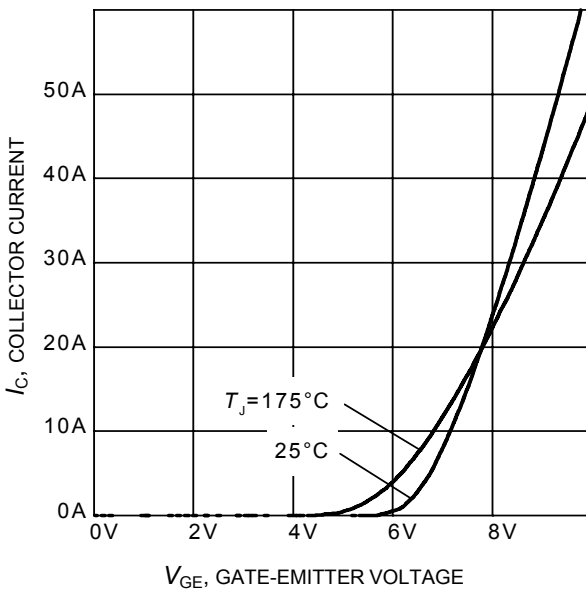
**Figure 4. Collector current as a function of case temperature**  
 $(V_{GE} \geq 15\text{V}, T_J \leq 175^\circ\text{C})$



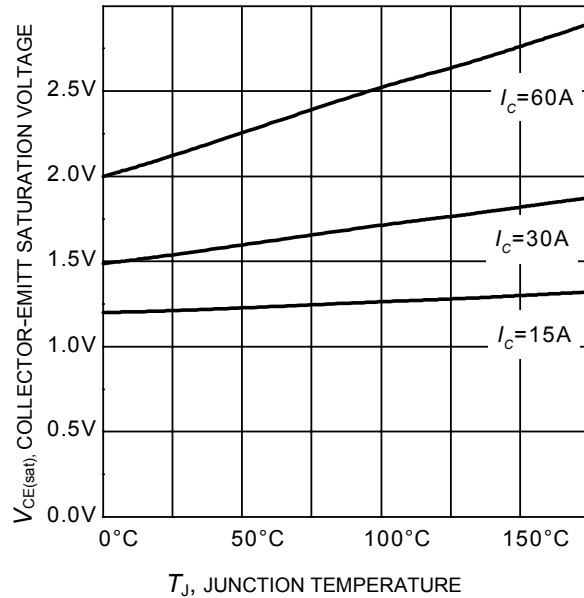
**Figure 5. Typical output characteristic**  
( $T_j = 25^\circ\text{C}$ )



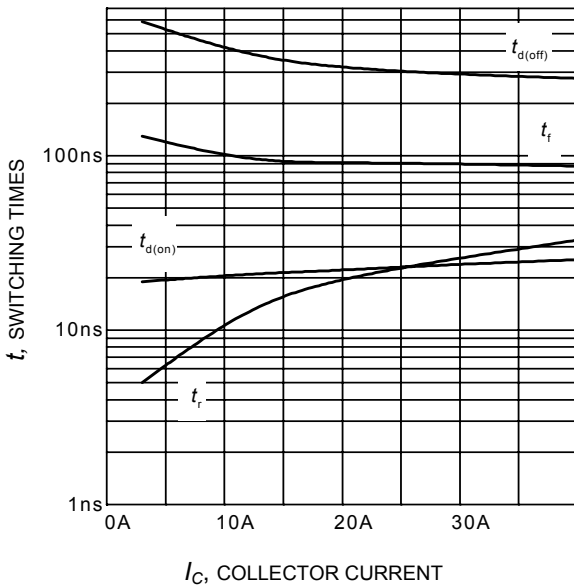
**Figure 6. Typical output characteristic**  
( $T_j = 175^\circ\text{C}$ )



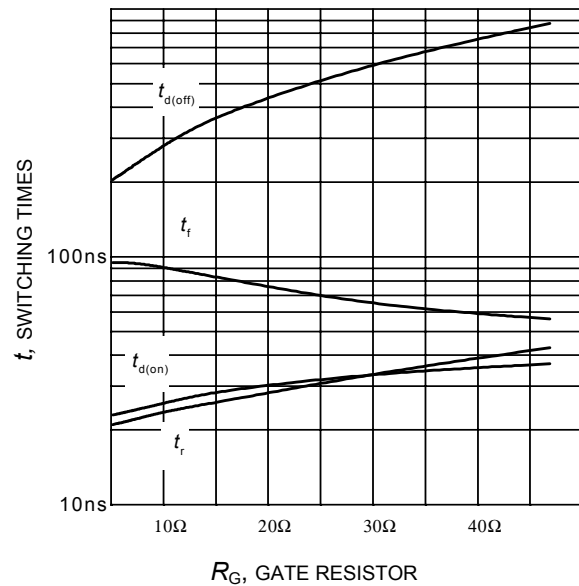
**Figure 7. Typical transfer characteristic**  
( $V_{CE} = 10\text{V}$ )



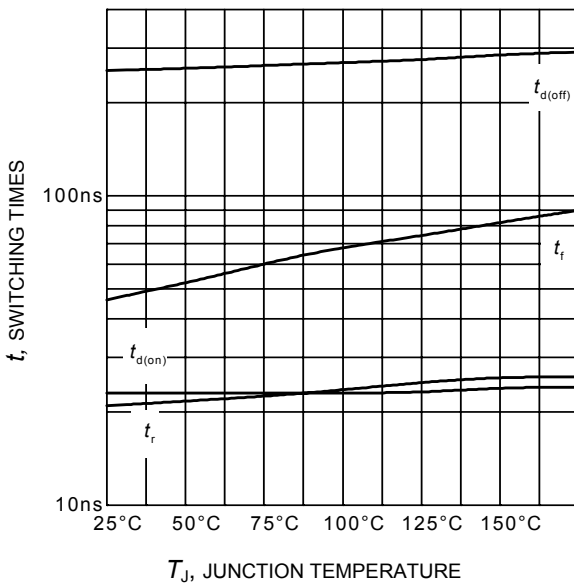
**Figure 8. Typical collector-emitter saturation voltage as a function of junction temperature**  
( $V_{GE} = 15\text{V}$ )



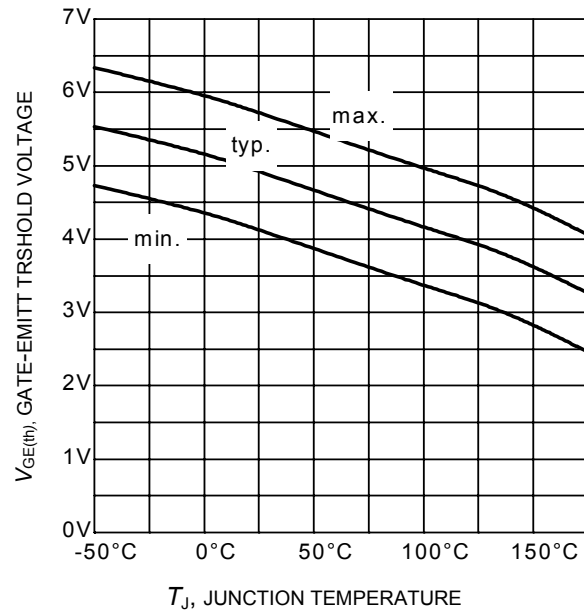
**Figure 9. Typical switching times as a function of collector current**  
(inductive load,  $T_J=175^\circ\text{C}$ ,  
 $V_{CE} = 400\text{V}$ ,  $V_{GE} = 0/15\text{V}$ ,  $R_G = 10\Omega$ ,  
Dynamic test circuit in Figure E)



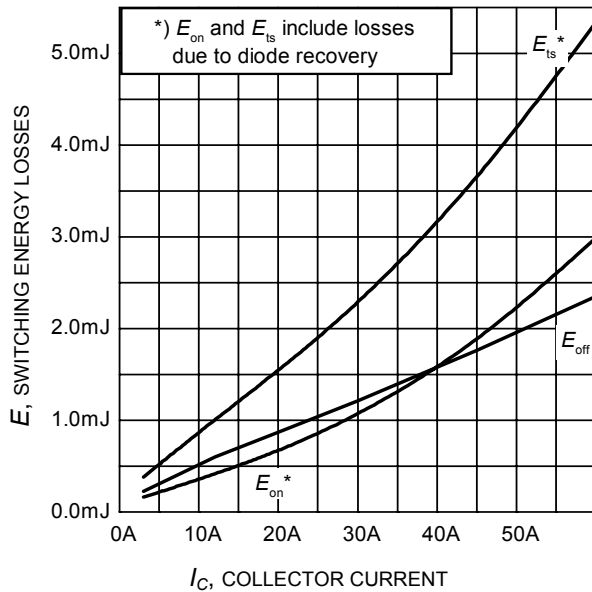
**Figure 10. Typical switching times as a function of gate resistor**  
(inductive load,  $T_J = 175^\circ\text{C}$ ,  
 $V_{CE} = 400\text{V}$ ,  $V_{GE} = 0/15\text{V}$ ,  $I_C = 30\text{A}$ ,  
Dynamic test circuit in Figure E)



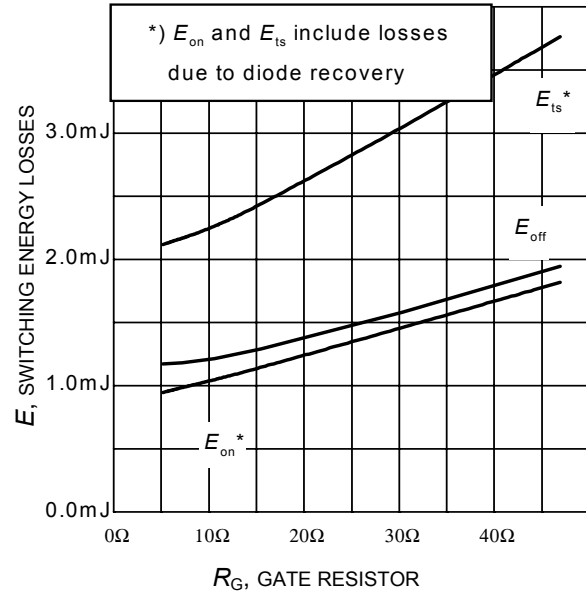
**Figure 11. Typical switching times as a function of junction temperature**  
(inductive load,  $V_{CE} = 400\text{V}$ ,  
 $V_{GE} = 0/15\text{V}$ ,  $I_C = 30\text{A}$ ,  $R_G=10\Omega$ ,  
Dynamic test circuit in Figure E)



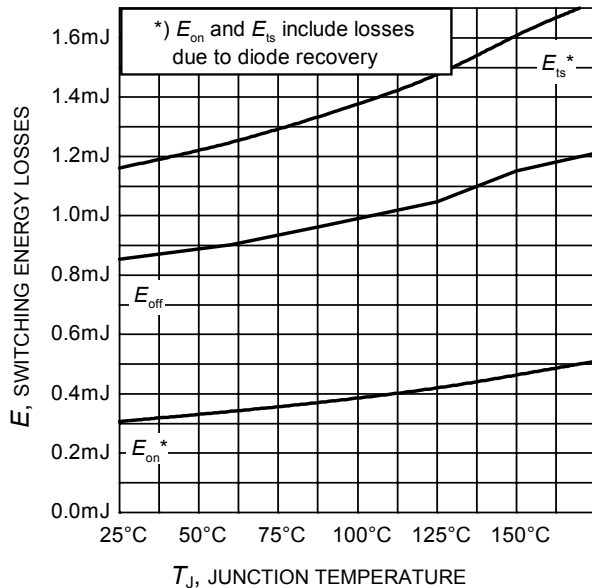
**Figure 12. Gate-emitter threshold voltage as a function of junction temperature**  
( $I_C = 0.43\text{mA}$ )



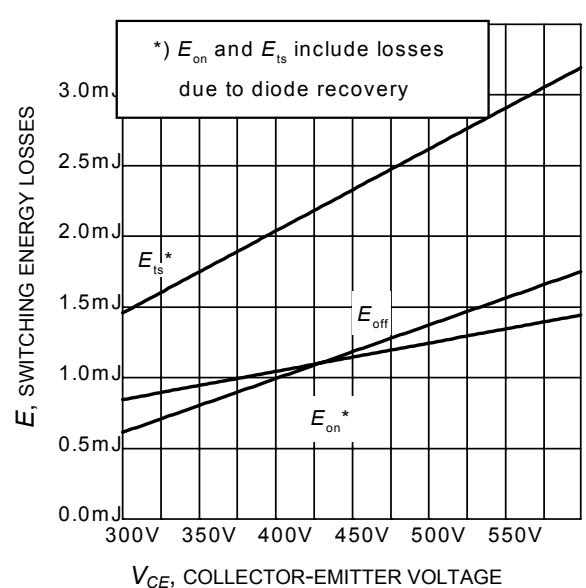
**Figure 13. Typical switching energy losses as a function of collector current**  
 (inductive load,  $T_J = 175^\circ\text{C}$ ,  $V_{CE} = 400\text{V}$ ,  $V_{GE} = 0/15\text{V}$ ,  $R_G = 10\Omega$ , Dynamic test circuit in Figure E)



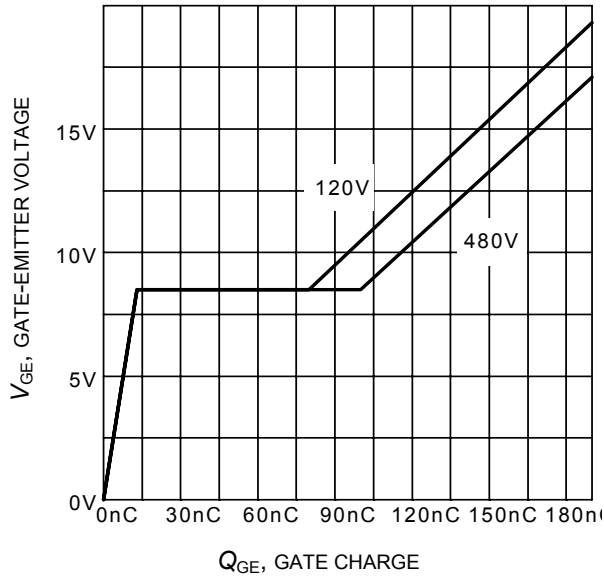
**Figure 14. Typical switching energy losses as a function of gate resistor**  
 (inductive load,  $T_J = 175^\circ\text{C}$ ,  $V_{CE} = 400\text{V}$ ,  $V_{GE} = 0/15\text{V}$ ,  $I_C = 30\text{A}$ , Dynamic test circuit in Figure E)



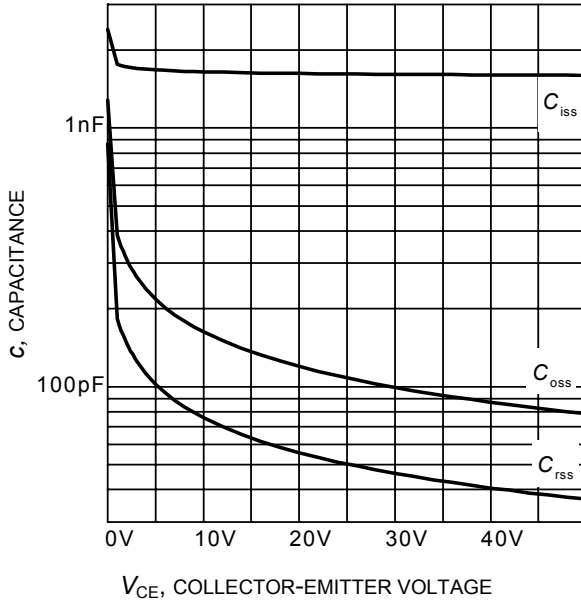
**Figure 15. Typical switching energy losses as a function of junction temperature**  
 (inductive load,  $V_{CE} = 400\text{V}$ ,  $V_{GE} = 0/15\text{V}$ ,  $I_C = 30\text{A}$ ,  $R_G = 10\Omega$ , Dynamic test circuit in Figure E)



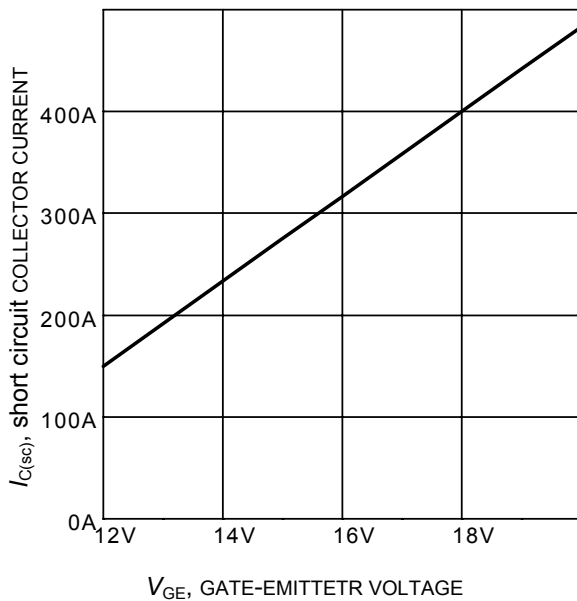
**Figure 16. Typical switching energy losses as a function of collector emitter voltage**  
 (inductive load,  $T_J = 175^\circ\text{C}$ ,  $V_{GE} = 0/15\text{V}$ ,  $I_C = 30\text{A}$ ,  $R_G = 10\Omega$ , Dynamic test circuit in Figure E)



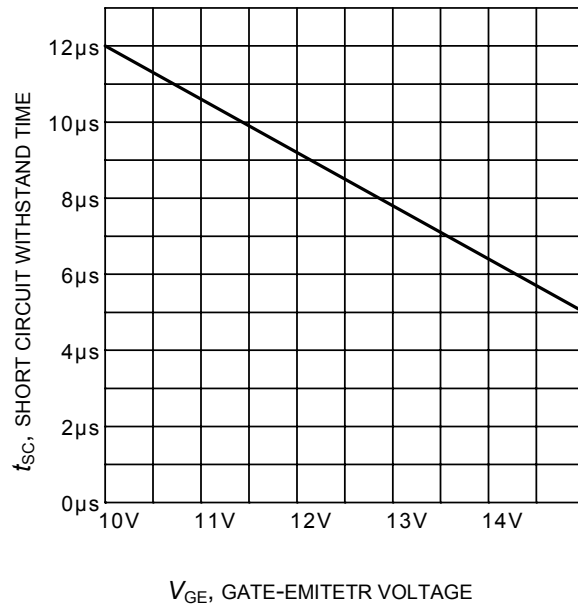
**Figure 17. Typical gate charge**  
( $I_C=30\text{ A}$ )



**Figure 18. Typical capacitance as a function of collector-emitter voltage**  
( $V_{GE}=0\text{V}$ ,  $f = 1\text{ MHz}$ )

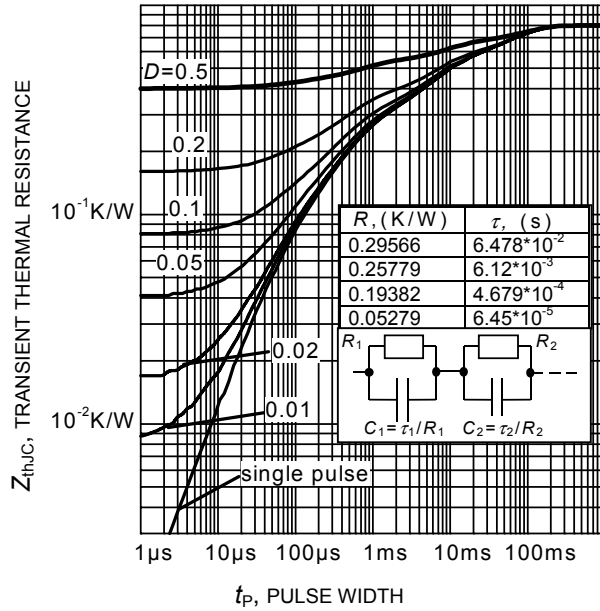


**Figure 19. Typical short circuit collector current as a function of gate-emitter voltage**  
( $V_{CE} \leq 400\text{V}$ ,  $T_j \leq 150^\circ\text{C}$ )

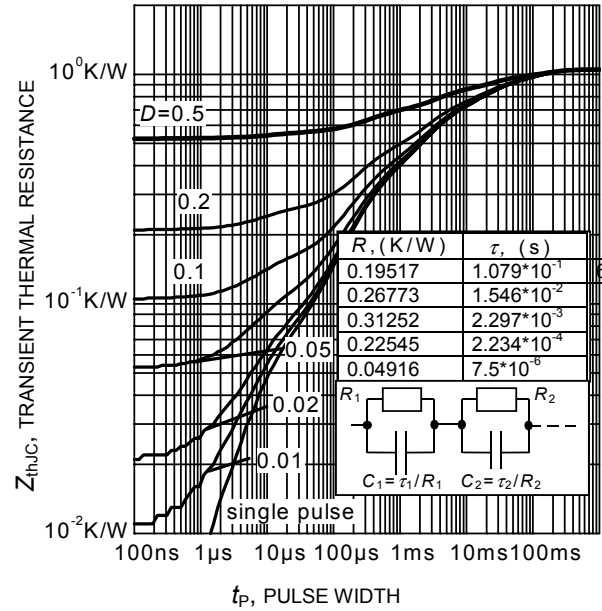


**Figure 20. Short circuit withstand time as a function of gate-emitter voltage**  
( $V_{CE}=600\text{V}$ , start at  $T_j=25^\circ\text{C}$ ,  $T_{jmax}<150^\circ\text{C}$ )

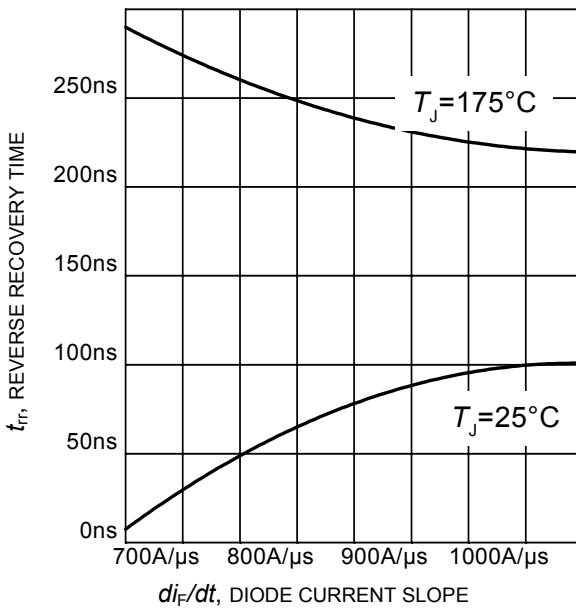




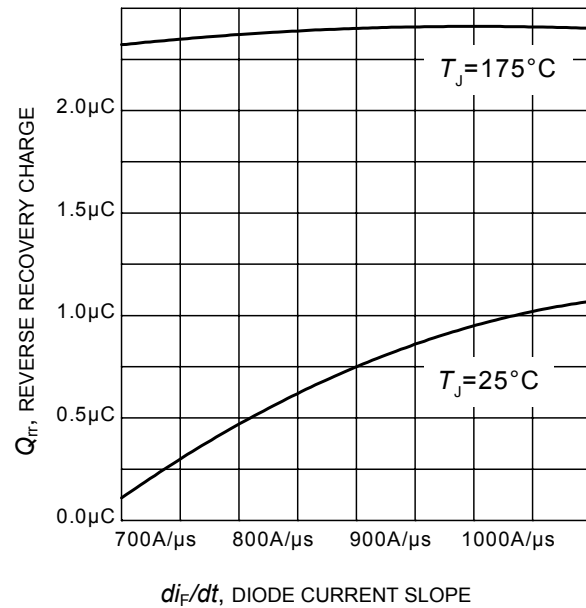
**Figure 21. IGBT transient thermal resistance**  
( $D = t_p / T$ )



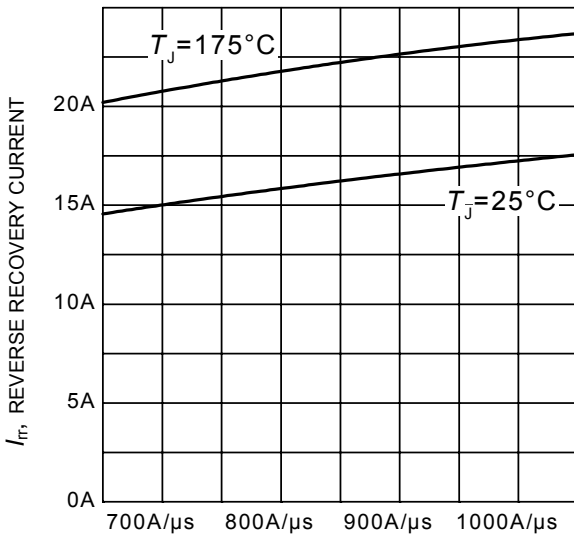
**Figure 22. Diode transient thermal impedance as a function of pulse width**  
( $D = t_p / T$ )



**Figure 23. Typical reverse recovery time as a function of diode current slope**  
( $V_R = 400V$ ,  $I_F = 30A$ ,  
Dynamic test circuit in Figure E)



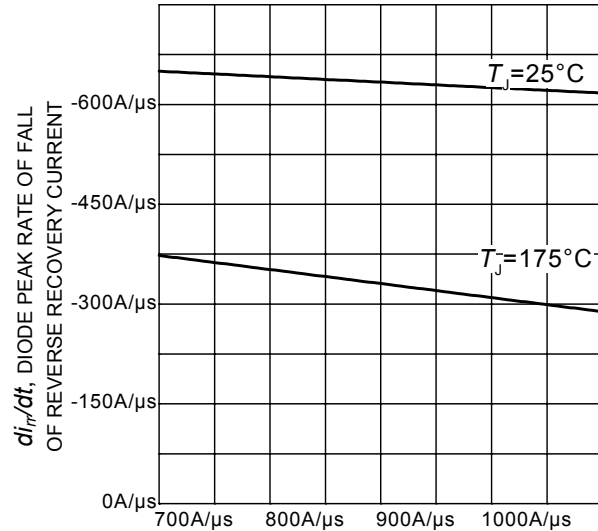
**Figure 24. Typical reverse recovery charge as a function of diode current slope**  
( $V_R = 400V$ ,  $I_F = 30A$ ,  
Dynamic test circuit in Figure E)



$di_F/dt$ , DIODE CURRENT SLOPE

**Figure 25. Typical reverse recovery current as a function of diode current slope**

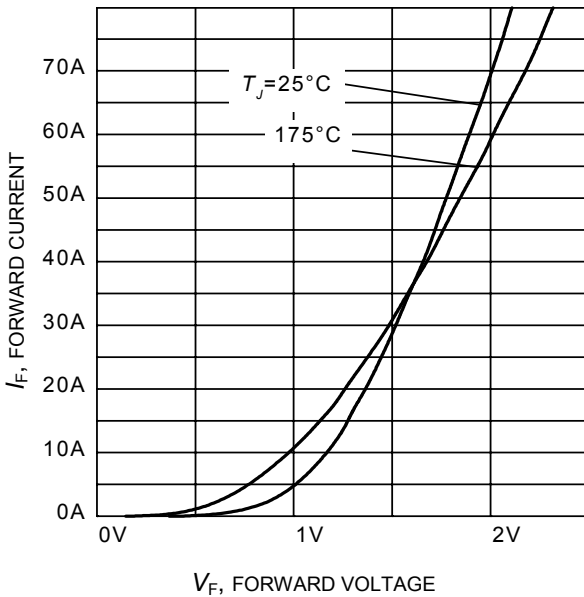
( $V_R = 400V$ ,  $I_F = 30A$ ,  
Dynamic test circuit in Figure E)



$di_F/dt$ , DIODE CURRENT SLOPE

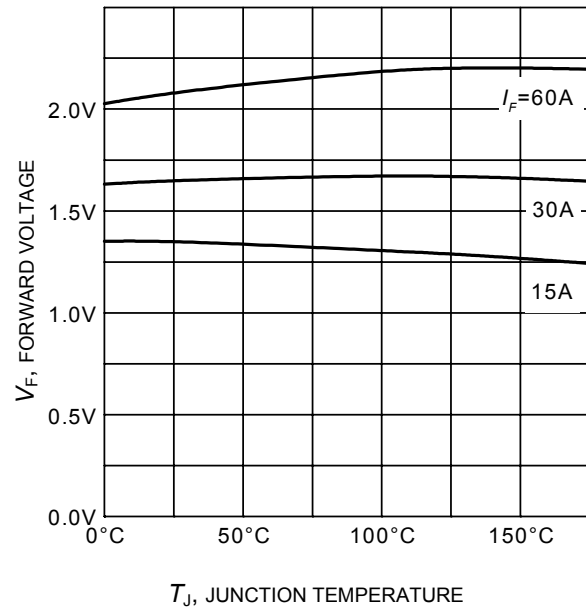
**Figure 26. Typical diode peak rate of fall of reverse recovery current as a function of diode current slope**

( $V_R = 400V$ ,  $I_F = 30A$ ,  
Dynamic test circuit in Figure E)



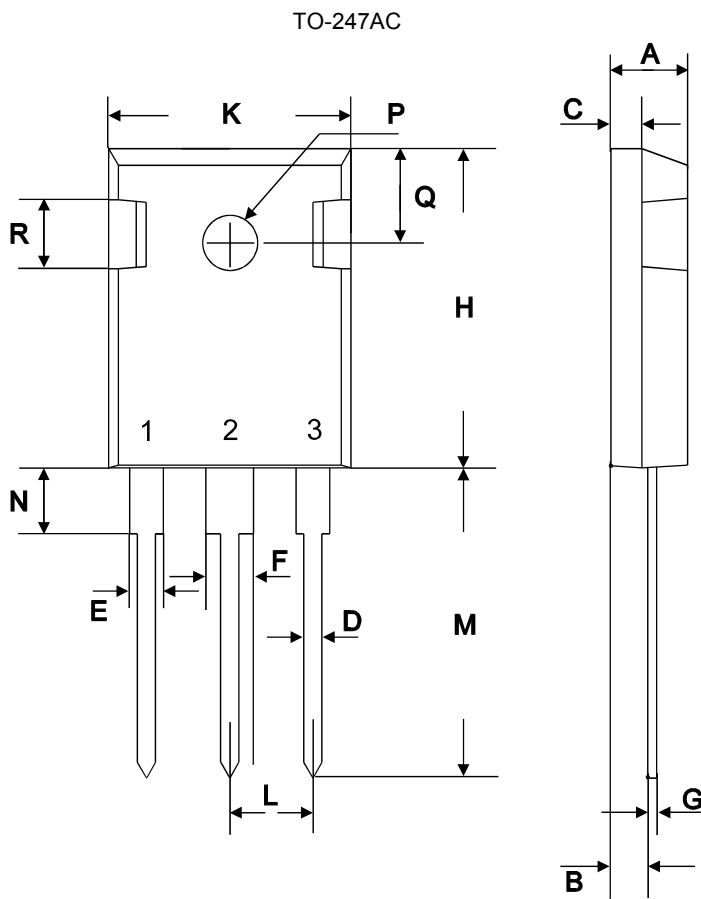
$V_F$ , FORWARD VOLTAGE

**Figure 27. Typical diode forward current as a function of forward voltage**

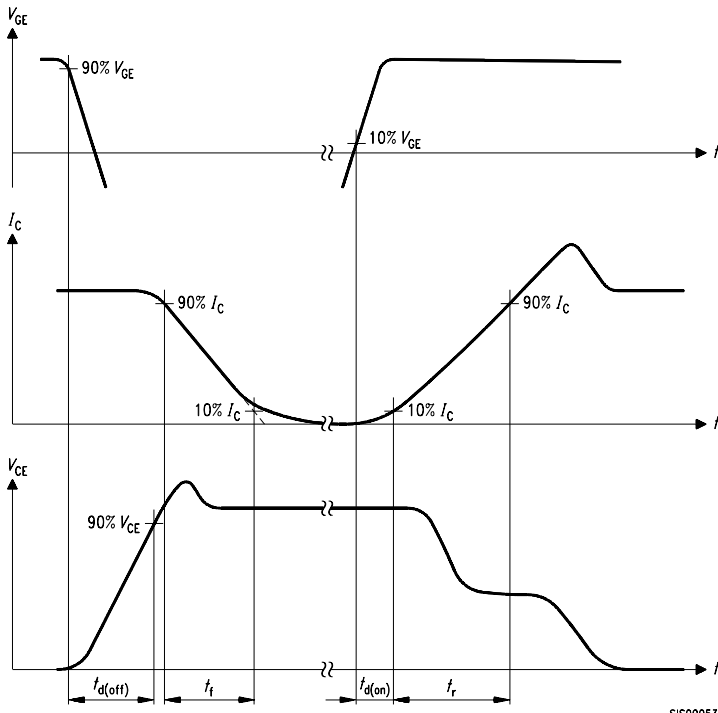


$T_J$ , JUNCTION TEMPERATURE

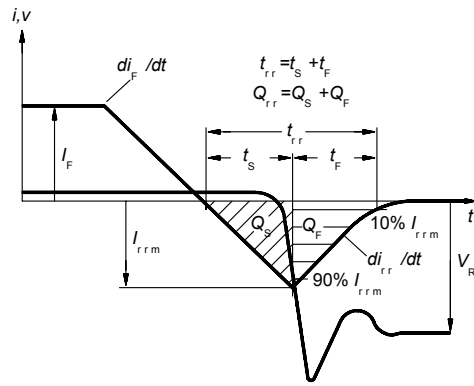
**Figure 28. Typical diode forward voltage as a function of junction temperature**



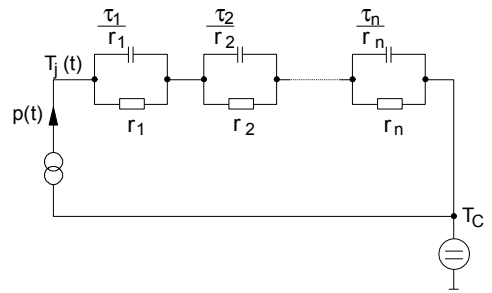
| symbol | dimensions |       |            |        |
|--------|------------|-------|------------|--------|
|        | [mm]       |       | [inch]     |        |
|        | min        | max   | min        | max    |
| A      | 4.78       | 5.28  | 0.1882     | 0.2079 |
| B      | 2.29       | 2.51  | 0.0902     | 0.0988 |
| C      | 1.78       | 2.29  | 0.0701     | 0.0902 |
| D      | 1.09       | 1.32  | 0.0429     | 0.0520 |
| E      | 1.73       | 2.06  | 0.0681     | 0.0811 |
| F      | 2.67       | 3.18  | 0.1051     | 0.1252 |
| G      | 0.76 max   |       | 0.0299 max |        |
| H      | 20.80      | 21.16 | 0.8189     | 0.8331 |
| K      | 15.65      | 16.15 | 0.6161     | 0.6358 |
| L      | 5.21       | 5.72  | 0.2051     | 0.2252 |
| M      | 19.81      | 20.68 | 0.7799     | 0.8142 |
| N      | 3.560      | 4.930 | 0.1402     | 0.1941 |
| ∅P     | 3.61       |       | 0.1421     |        |
| Q      | 6.12       | 6.22  | 0.2409     | 0.2449 |



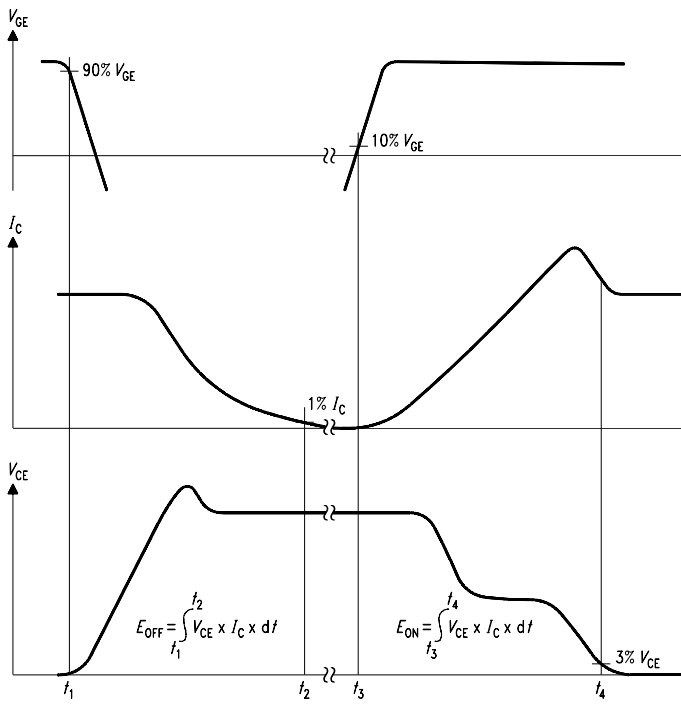
**Figure A. Definition of switching times**



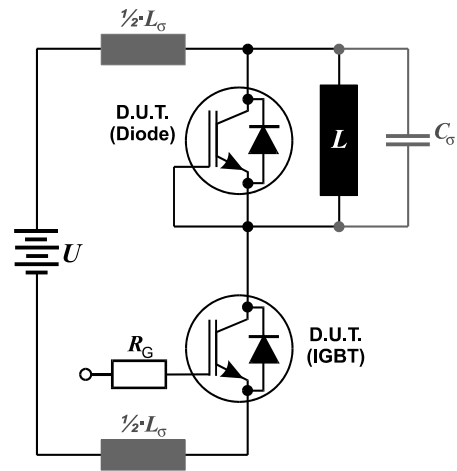
**Figure C. Definition of diodes switching characteristics**



**Figure D. Thermal equivalent circuit**



**Figure B. Definition of switching losses**



**Figure E. Dynamic test circuit**

**Published by**  
**Infineon Technologies AG,**  
**Bereich Kommunikation**  
**St.-Martin-Strasse 53,**  
**D-81541 München**  
**© Infineon Technologies AG 2004**  
**All Rights Reserved.**

**Attention please!**

The information herein is given to describe certain components and shall not be considered as warranted characteristics.

Terms of delivery and rights to technical change reserved.

We hereby disclaim any and all warranties, including but not limited to warranties of non-infringement, regarding circuits, descriptions and charts stated herein.

Infineon Technologies is an approved CECC manufacturer.

**Information**

For further information on technology, delivery terms and conditions and prices please contact your nearest Infineon Technologies Office in Germany or our Infineon Technologies Representatives worldwide (see address list).

**Warnings**

Due to technical requirements components may contain dangerous substances. For information on the types in question please contact your nearest Infineon Technologies Office.

Infineon Technologies Components may only be used in life-support devices or systems with the express written approval of Infineon Technologies, if a failure of such components can reasonably be expected to cause the failure of that life-support device or system, or to affect the safety or effectiveness of that device or system. Life support devices or systems are intended to be implanted in the human body, or to support and/or maintain and sustain and/or protect human life. If they fail, it is reasonable to assume that the health of the user or other persons may be endangered.