

# SKM 200GB176D

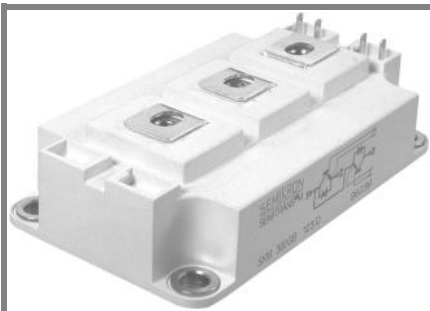

**SEMITRANS® 3**

## Trench IGBT Modules

**SKM 200GB176D**

**SKM 200GAL176D**

### Features

- Homogeneous Si
- Trench = Trenchgate technology
- $V_{CEsat}$  with positive temperature coefficient
- High short circuit capability, self limiting to  $6 \times I_C$

### Typical Applications\*

- AC inverter drives mains 575 - 750 V AC
- Public transport (auxiliary syst.)

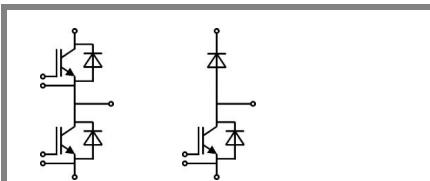

**GB**

**GAL**

Absolute Maximum Ratings		$T_c = 25\text{ °C}$ , unless otherwise specified		
Symbol	Conditions	Values		Units
<b>IGBT</b>				
$V_{CES}$	$T_j = 25\text{ °C}$	1700		V
$I_C$	$T_j = 150\text{ °C}$	$T_c = 25\text{ °C}$	260	A
		$T_c = 80\text{ °C}$	180	A
$I_{CRM}$	$I_{CRM} = 2 \times I_{Cnom}$	300		A
$V_{GES}$		± 20		V
$t_{psc}$	$V_{CC} = 1200\text{ V}; V_{GE} \leq 20\text{ V}; T_j = 125\text{ °C}$ $V_{CES} < 1700\text{ V}$	10		µs
<b>Inverse Diode</b>				
$I_F$	$T_j = 150\text{ °C}$	$T_c = 25\text{ °C}$	210	A
		$T_c = 80\text{ °C}$	140	A
$I_{FRM}$	$I_{FRM} = 2 \times I_{Fnom}$	300		A
$I_{FSM}$	$t_p = 10\text{ ms}; \sin.$	$T_j = 150\text{ °C}$	1100	A
<b>Freewheeling Diode</b>				
$I_F$	$T_j = 150\text{ °C}$	$T_{case} = 25\text{ °C}$	210	A
		$T_{case} = 80\text{ °C}$	140	A
$I_{FRM}$	$I_{FRM} = 2 \times I_{Fnom}$	300		A
$I_{FSM}$	$t_p = 10\text{ ms}; \sin.$	$T_j = 150\text{ °C}$	1100	A
<b>Module</b>				
$I_{t(RMS)}$		500		A
$T_{vj}$		- 40 ... + 150		°C
$T_{stg}$		-40...+125		°C
$V_{isol}$	AC, 1 min.	4000		V

Characteristics		$T_c = 25\text{ °C}$ , unless otherwise specified			
Symbol	Conditions	min.	typ.	max.	Units
<b>IGBT</b>					
$V_{GE(th)}$	$V_{GE} = V_{CE}, I_C = 6\text{ mA}$	5,2	5,8	6,4	V
$I_{CES}$	$V_{GE} = 0\text{ V}, V_{CE} = V_{CES}$			3	mA
$V_{CE0}$		$T_j = 25\text{ °C}$	1	1,2	V
		$T_j = 125\text{ °C}$	0,9	1,1	V
$r_{CE}$	$V_{GE} = 15\text{ V}$	$T_j = 25\text{ °C}$	6,7	8,3	mΩ
		$T_j = 125\text{ °C}$	10	12	mΩ
$V_{CE(sat)}$	$I_{Cnom} = 150\text{ A}, V_{GE} = 15\text{ V}$	$T_j = 25\text{ °C}_{chiplev.}$	2	2,45	V
		$T_j = 125\text{ °C}_{chiplev.}$	2,4	2,9	V
$C_{ies}$	$V_{CE} = 25, V_{GE} = 0\text{ V}$	$f = 1\text{ MHz}$	11,4		nF
$C_{oes}$			0,55		nF
$C_{res}$			0,44		nF
$Q_G$	$V_{GE} = -8V...+15V$	1200		nC	
$R_{Gint}$	$T_j = 25\text{ °C}$	4,25		Ω	
$t_{d(on)}$	$R_{Gon} = 5\text{ Ω}$	$V_{CC} = 1200V$ $I_C = 150A$	360		ns
			$T_j = 125\text{ °C}$	45	ns
$E_{on}$	$R_{Goff} = 5\text{ Ω}$	$V_{GE} = \pm 15V$	93		mJ
$t_{d(off)}$			760	ns	
$t_f$			140	ns	
$E_{off}$			58		mJ
$R_{th(j-c)}$	per IGBT			0,12	K/W

# SKM 200GB176D

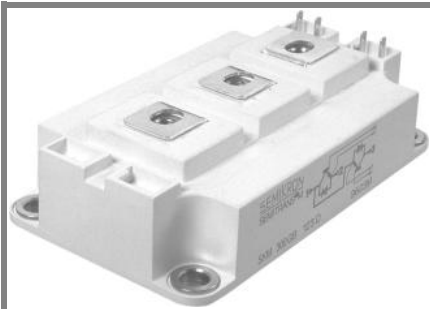

**SEMITRANS® 3**

## Trench IGBT Modules

**SKM 200GB176D**

**SKM 200GAL176D**

### Features

- Homogeneous Si
- Trench = Trenchgate technology
- $V_{CEsat}$  with positive temperature coefficient
- High short circuit capability, self limiting to  $6 \times I_c$

### Typical Applications\*

- AC inverter drives mains 575 - 750 V AC
- Public transport (auxiliary syst.)

Characteristics				min.	typ.	max.	Units
Symbol	Conditions						
<b>Inverse Diode</b>							
$V_F = V_{EC}$	$I_{Fnom} = 150 \text{ A}; V_{GE} = 0 \text{ V}$	$T_j = 25 \text{ }^\circ\text{C}_{chiplev.}$		1,7	1,9		V
		$T_j = 125 \text{ }^\circ\text{C}_{chiplev.}$		1,7	1,9		V
$V_{F0}$		$T_j = 25 \text{ }^\circ\text{C}$		1,1	1,3		V
		$T_j = 125 \text{ }^\circ\text{C}$		0,9	1,1		V
$r_F$		$T_j = 25 \text{ }^\circ\text{C}$		4	4		mΩ
		$T_j = 125 \text{ }^\circ\text{C}$		5,3	5,3		mΩ
$I_{RRM}$	$I_F = 150 \text{ A}$	$T_j = 125 \text{ }^\circ\text{C}$		195			A
$Q_{rr}$	$di/dt = 3700 \text{ A}/\mu\text{s}$			52			μC
$E_{rr}$	$V_{GE} = -15 \text{ V}; V_{CC} = 1200 \text{ V}$			31			mJ
$R_{th(j-c)D}$	per diode				0,25		K/W
<b>FWD</b>							
$V_F = V_{EC}$	$I_{Fnom} = 150 \text{ A}; V_{GE} = 0 \text{ V}$	$T_j = 25 \text{ }^\circ\text{C}_{chiplev.}$		1,7	1,9		V
		$T_j = 125 \text{ }^\circ\text{C}_{chiplev.}$		1,7	1,9		V
$V_{F0}$		$T_j = 25 \text{ }^\circ\text{C}$		1,1	1,3		V
		$T_j = 125 \text{ }^\circ\text{C}$		0,9	1,1		V
$r_F$		$T_j = 25 \text{ }^\circ\text{C}$		4	4		V
		$T_j = 125 \text{ }^\circ\text{C}$		5,3	5,3		V
$I_{RRM}$	$I_F = 150 \text{ A}$	$T_j = 125 \text{ }^\circ\text{C}$		195			A
$Q_{rr}$	$di/dt = 3700 \text{ A}/\mu\text{s}$			52			μC
$E_{rr}$	$V_{GE} = -15 \text{ V}; V_{CC} = 1200 \text{ V}$			31			mJ
$R_{th(j-c)FD}$	per diode				0,25		K/W
<b>Module</b>							
$L_{CE}$				15	20		nH
$R_{CC'+EE'}$	res., terminal-chip	$T_{case} = 25 \text{ }^\circ\text{C}$		0,35			mΩ
		$T_{case} = 125 \text{ }^\circ\text{C}$		0,5			mΩ
$R_{th(c-s)}$	per module				0,038		K/W
$M_s$	to heat sink M6			3	5		Nm
$M_t$	to terminals M6			2,5	5		Nm
w					325		g

This is an electrostatic discharge sensitive device (ESDS), international standard IEC 60747-1, Chapter IX.

\* The specifications of our components may not be considered as an assurance of component characteristics. Components have to be tested for the respective application. Adjustments may be necessary. The use of SEMIKRON products in life support appliances and systems is subject to prior specification and written approval by SEMIKRON. We therefore strongly recommend prior consultation of our personal.

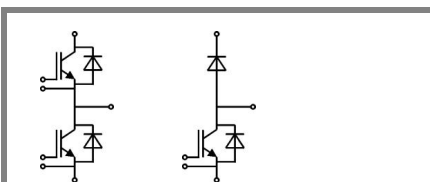

**GB**

**GAL**

# SKM 200GB176D

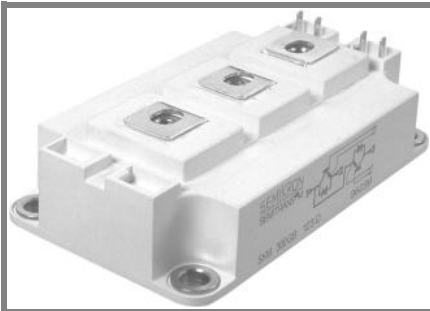

**SEMITRANS® 3**

## Trench IGBT Modules

**SKM 200GB176D**

**SKM 200GAL176D**

### Features

- Homogeneous Si
- Trench = Trenchgate technology
- $V_{CEsat}$  with positive temperature coefficient
- High short circuit capability, self limiting to  $6 \times I_c$

### Typical Applications\*

- AC inverter drives mains 575 - 750 V AC
- Public transport (auxiliary syst.)

$Z_{th}$		Conditions	Values	Units
<b><math>Z_{th(j-c)I}</math></b>				
$R_{\theta j-c}$		$i = 1$	80	mk/W
$R_{\theta j-c}$		$i = 2$	30	mk/W
$R_{\theta j-c}$		$i = 3$	8,2	mk/W
$R_{\theta j-c}$		$i = 4$	1,8	mk/W
$\tau_{\theta j-c}$		$i = 1$	0,0753	s
$\tau_{\theta j-c}$		$i = 2$	0,01	s
$\tau_{\theta j-c}$		$i = 3$	0,0008	s
$\tau_{\theta j-c}$		$i = 4$	0,0003	s
<b><math>Z_{th(j-c)D}</math></b>				
$R_{\theta j-c}$		$i = 1$	160	mk/W
$R_{\theta j-c}$		$i = 2$	67	mk/W
$R_{\theta j-c}$		$i = 3$	20	mk/W
$R_{\theta j-c}$		$i = 4$	3	mk/W
$\tau_{\theta j-c}$		$i = 1$	0,0382	s
$\tau_{\theta j-c}$		$i = 2$	0,009	s
$\tau_{\theta j-c}$		$i = 3$	0,0009	s
$\tau_{\theta j-c}$		$i = 4$	0,005	s

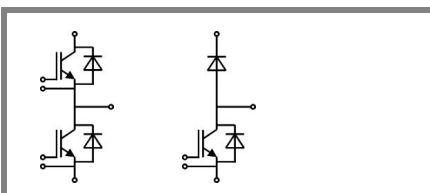

**GB**

**GAL**

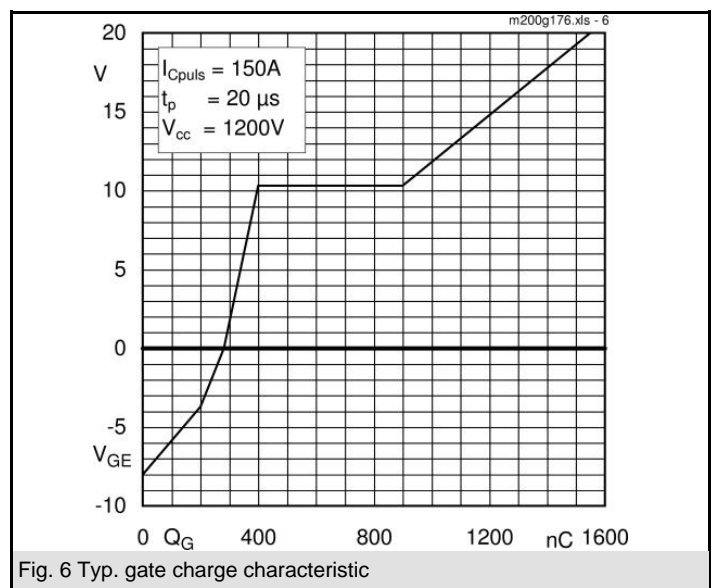
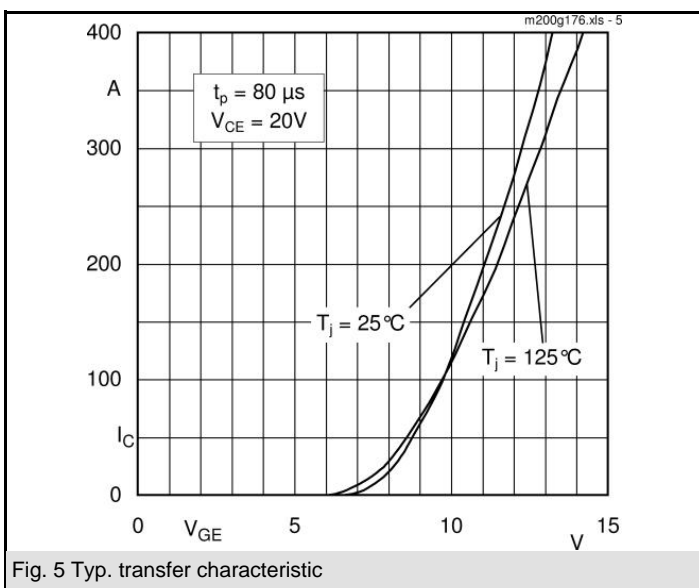
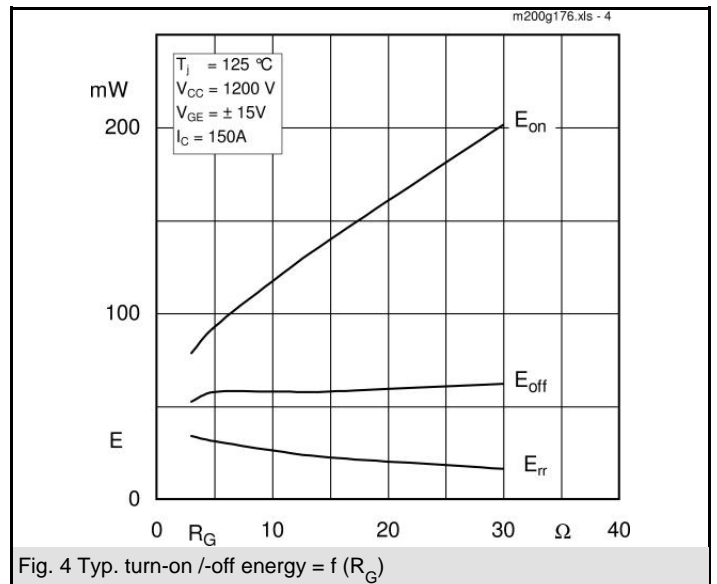
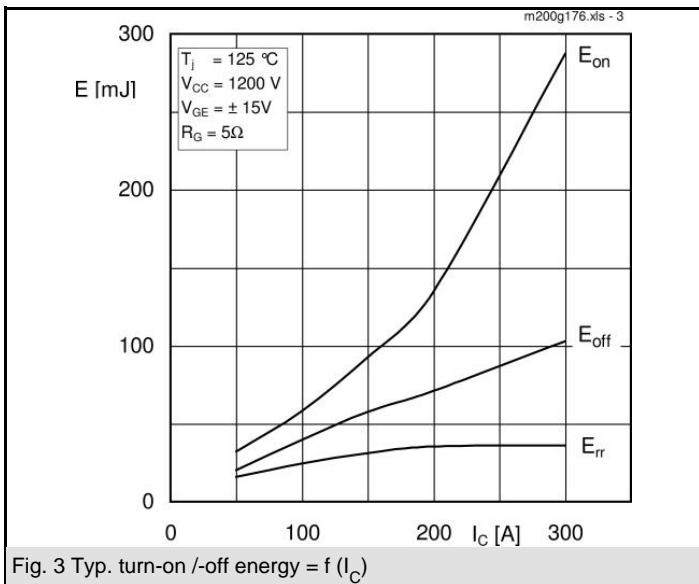
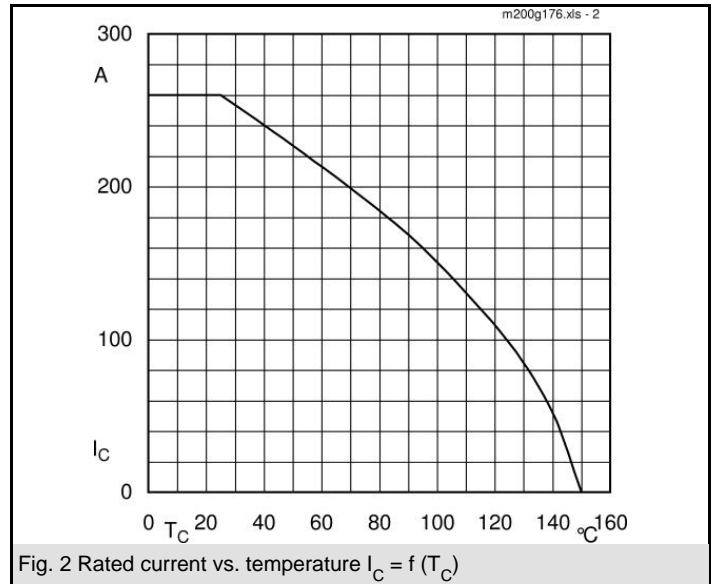
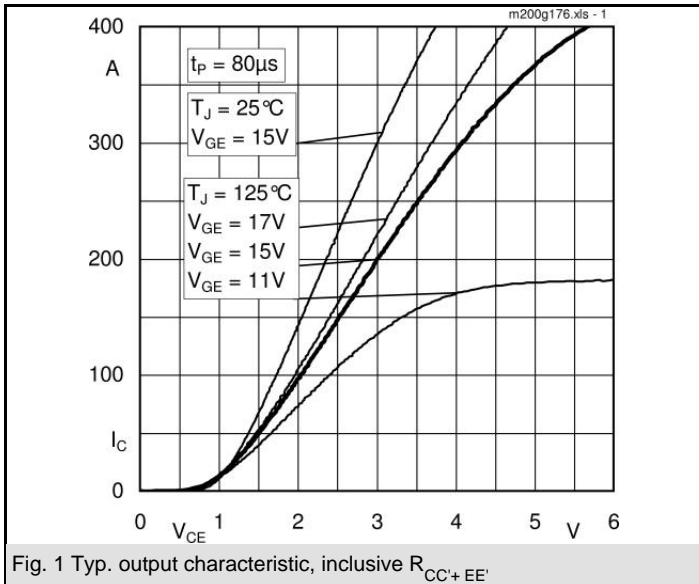

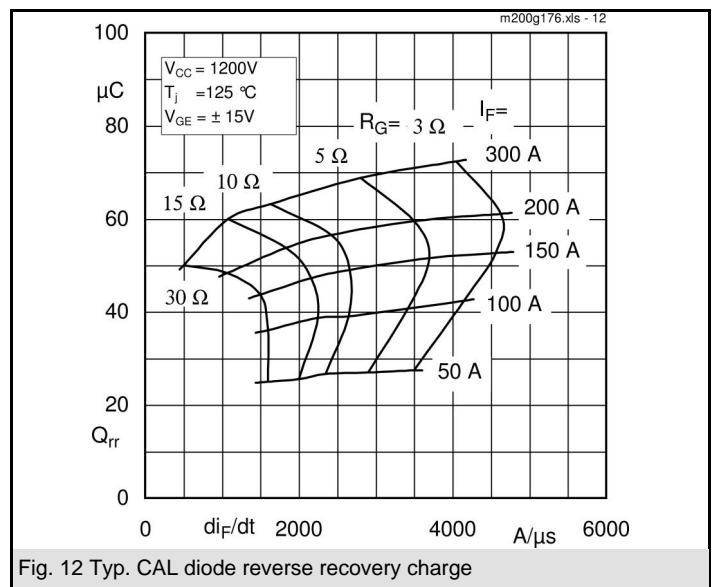
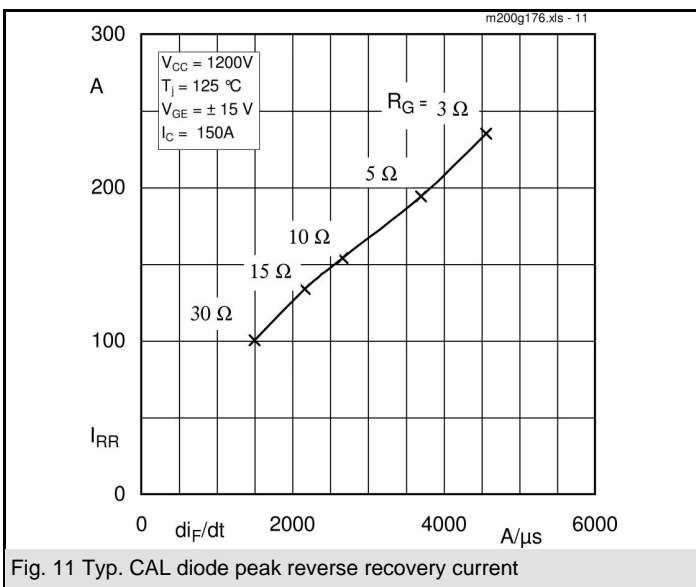
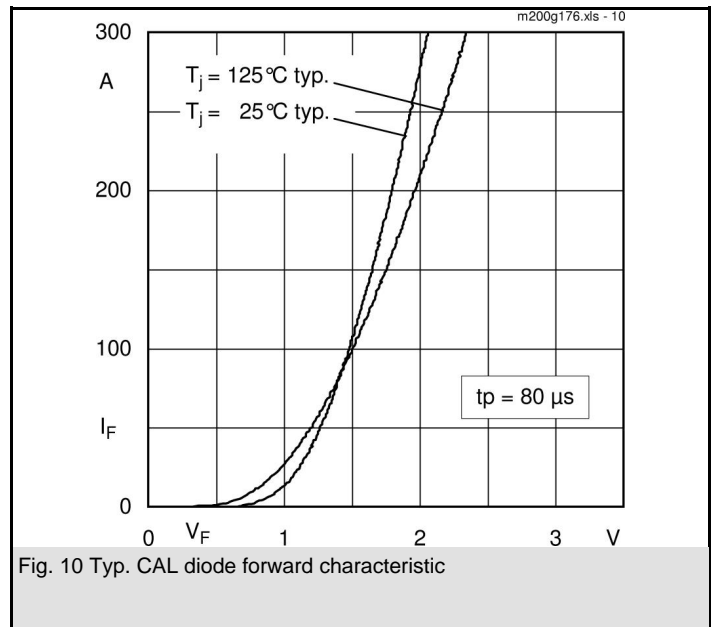
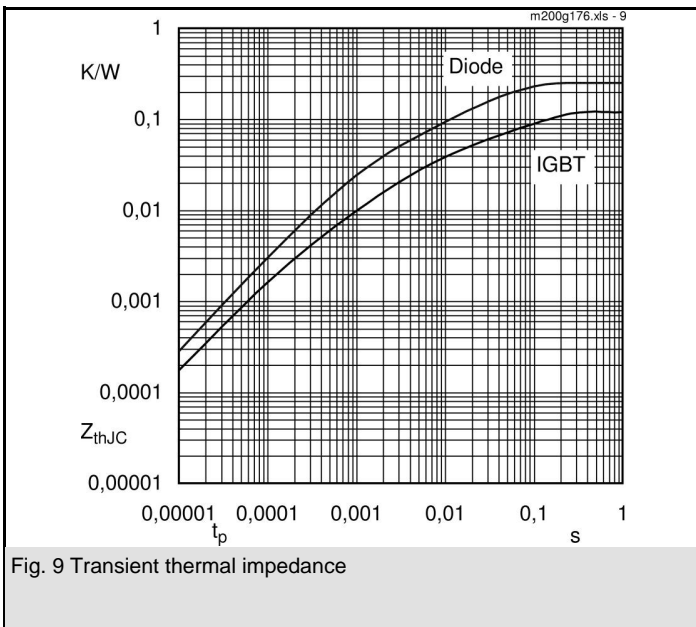
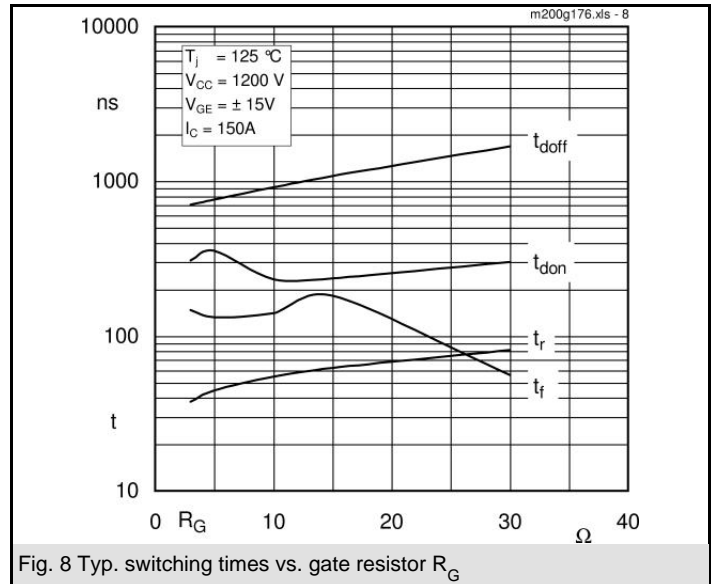
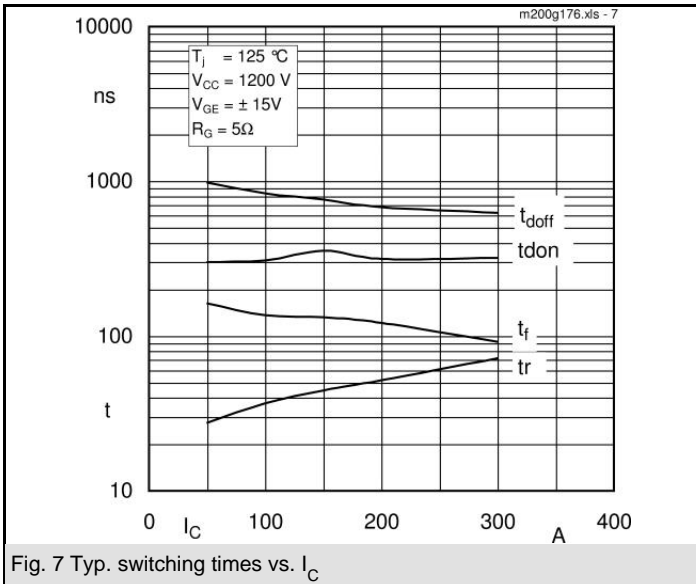

# SKM 200GB176D

UL Recognized

CASED56

File no. E 63 532

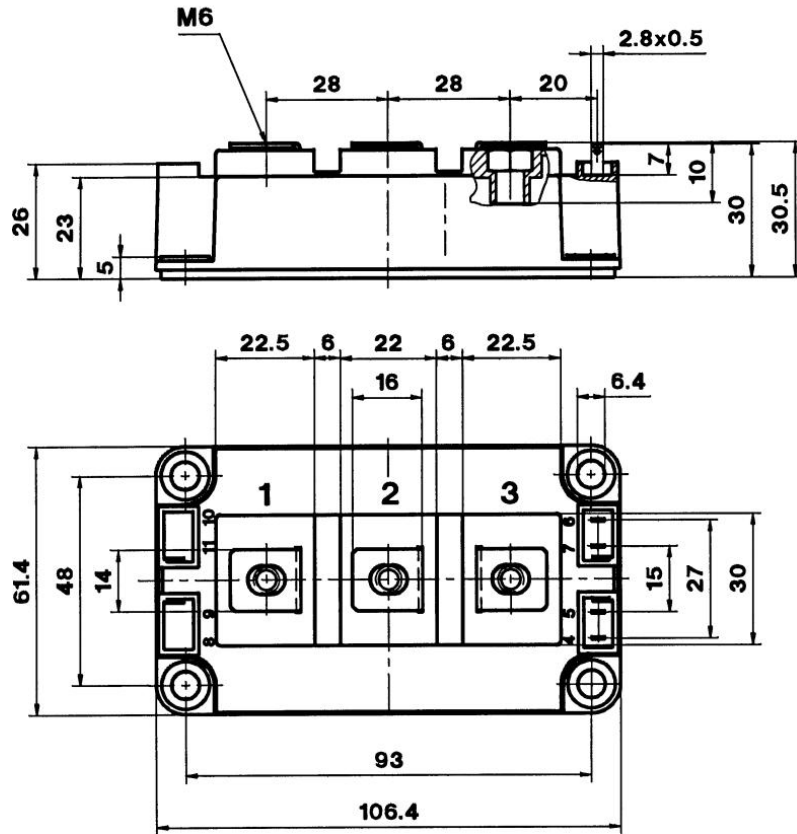

Case D 56

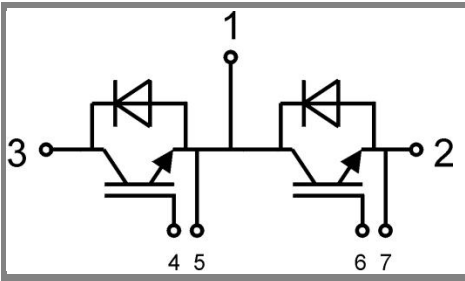

GB Case D 56

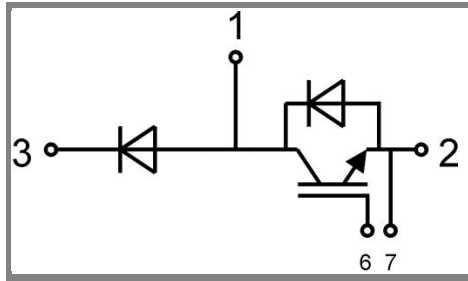

GAL Case D 57