

# SKM75GB12T4



SEMITRANS®2

## Fast IGBT4 Modules

SKM75GB12T4

### Features

- $V_{CE(sat)}$  with positive temperature coefficient
- High short circuit capability, self limiting to 6 x  $I_{Cnom}$
- Fast & soft inverse CAL diodes
- Large clearance (10 mm) and creepage distances (20 mm)
- Isolated copper baseplate using DBC Technology (Direct Copper Bonding)

### Typical Applications

- AC inverter drives
- UPS
- Electronic welders at fsw up to 20 kHz

### Remarks

- Case temperature limited to  $T_c = 125^\circ\text{C}$  max, recomm.  
 $T_{op} = -40 \dots +150^\circ\text{C}$ , product rel. results valid for  $T_j = 150^\circ$

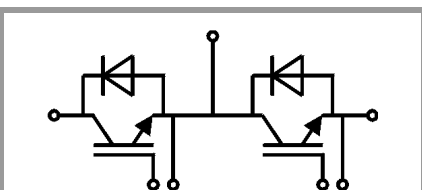

GB

Absolute Maximum Ratings				
Symbol	Conditions	Values	Unit	
<b>IGBT</b>				
$V_{CES}$		1200	V	
$I_C$	$T_j = 175^\circ\text{C}$	$T_c = 25^\circ\text{C}$	115	A
		$T_c = 80^\circ\text{C}$	88	A
$I_{Cnom}$		75	A	
$I_{CRM}$	$I_{CRM} = 3 \times I_{Cnom}$	225	A	
$V_{GES}$		-20 ... 20	V	
$t_{psc}$	$V_{CC} = 800\text{ V}$	$T_j = 150^\circ\text{C}$	10	$\mu\text{s}$
	$V_{GE} \leq 15\text{ V}$			
	$V_{CES} \leq 1200\text{ V}$			
$T_j$		-40 ... 175		$^\circ\text{C}$
<b>Inverse diode</b>				
$I_F$	$T_j = 175^\circ\text{C}$	$T_c = 25^\circ\text{C}$	97	A
		$T_c = 80^\circ\text{C}$	73	A
$I_{Fnom}$		75	A	
$I_{FRM}$	$I_{FRM} = 3 \times I_{Fnom}$	225	A	
$I_{FSM}$	$t_p = 10\text{ ms, sin } 180^\circ, T_j = 25^\circ\text{C}$	430	A	
$T_j$		-40 ... 175		$^\circ\text{C}$
<b>Module</b>				
$I_{t(RMS)}$		200		A
$T_{stg}$		-40 ... 125		$^\circ\text{C}$
$V_{isol}$	AC sinus 50Hz, t = 1 min	4000		V

Characteristics					
Symbol	Conditions	min.	typ.	max.	Unit
<b>IGBT</b>					
$V_{CE(sat)}$	$I_C = 75\text{ A}$ $V_{GE} = 15\text{ V}$ chipelevel	$T_j = 25^\circ\text{C}$	1.85	2.1	V
		$T_j = 150^\circ\text{C}$	2.25	2.45	V
$V_{CE0}$		$T_j = 25^\circ\text{C}$	0.8	0.9	V
		$T_j = 150^\circ\text{C}$	0.7	0.8	V
$r_{CE}$	$V_{GE} = 15\text{ V}$	$T_j = 25^\circ\text{C}$	14.0	16.0	$\text{m}\Omega$
		$T_j = 150^\circ\text{C}$	20.7	22.0	$\text{m}\Omega$
$V_{GE(th)}$	$V_{GE} = V_{CE}, I_C = 3\text{ mA}$	5	5.8	6.5	V
$I_{CES}$	$V_{GE} = 0\text{ V}$ $V_{CE} = 1200\text{ V}$	$T_j = 25^\circ\text{C}$	0.1	0.3	$\text{mA}$
		$T_j = 150^\circ\text{C}$			$\text{mA}$
$C_{ies}$	$V_{CE} = 25\text{ V}$ $V_{GE} = 0\text{ V}$	$f = 1\text{ MHz}$	4.4		nF
$C_{oes}$		$f = 1\text{ MHz}$	0.29		nF
$C_{res}$		$f = 1\text{ MHz}$	0.235		nF
$Q_G$	$V_{GE} = -8\text{ V} \dots +15\text{ V}$		425		nC
$R_{Gint}$	$T_j = 25^\circ\text{C}$		10.0		$\Omega$
$t_{d(on)}$	$V_{CC} = 600\text{ V}$	$T_j = 150^\circ\text{C}$	150		ns
$t_r$	$I_C = 75\text{ A}$ $V_{GE} = \pm 15\text{ V}$	$T_j = 150^\circ\text{C}$	39		ns
		$T_j = 150^\circ\text{C}$	11		mJ
$E_{on}$	$R_{Gon} = 1\ \Omega$	$T_j = 150^\circ\text{C}$			mJ
$t_{d(off)}$	$R_{Goff} = 1\ \Omega$	$T_j = 150^\circ\text{C}$	370		ns
$t_f$	$di/dt_{on} = 1600\text{ A}/\mu\text{s}$	$T_j = 150^\circ\text{C}$	66		ns
$E_{off}$	$di/dt_{off} = 950\text{ A}/\mu\text{s}$	$T_j = 150^\circ\text{C}$	6.9		mJ
$R_{th(j-c)}$	per IGBT			0.38	K/W



**SEMITRANS®2**

## Fast IGBT4 Modules

SKM75GB12T4

### Features

- $V_{CE(sat)}$  with positive temperature coefficient
- High short circuit capability, self limiting to  $6 \times I_{cnom}$
- Fast & soft inverse CAL diodes
- Large clearance (10 mm) and creepage distances (20 mm)
- Isolated copper baseplate using DBC Technology (Direct Copper Bonding)

### Typical Applications

- AC inverter drives
- UPS
- Electronic welders at fsw up to 20 kHz

### Remarks

- Case temperature limited to  $T_c = 125^\circ\text{C}$  max, recomm.  
 $T_{op} = -40 \dots +150^\circ\text{C}$ , product rel. results valid for  $T_j = 150^\circ$

Characteristics						
Symbol	Conditions		min.	typ.	max.	Unit
<b>Inverse diode</b>						
$V_F = V_{EC}$	$I_F = 75 \text{ A}$ $V_{GE} = 0 \text{ V}$ chip	$T_j = 25^\circ\text{C}$		2.17	2.49	V
		$T_j = 150^\circ\text{C}$		2.11	2.42	V
$V_{F0}$		$T_j = 25^\circ\text{C}$		1.3	1.5	V
		$T_j = 150^\circ\text{C}$		0.9	1.1	V
$r_F$		$T_j = 25^\circ\text{C}$		11.6	13.2	m $\Omega$
		$T_j = 150^\circ\text{C}$		16.1	17.6	m $\Omega$
$I_{RRM}$	$I_F = 75 \text{ A}$	$T_j = 150^\circ\text{C}$		37		A
$Q_{rr}$	$di/dt_{off} = 990 \text{ A}/\mu\text{s}$	$T_j = 150^\circ\text{C}$		12.6		$\mu\text{C}$
$E_{rr}$	$V_{GE} = \pm 15 \text{ V}$ $V_{CC} = 600 \text{ V}$	$T_j = 150^\circ\text{C}$		4.7		mJ
$R_{th(j-c)}$	per diode				0.58	K/W
<b>Module</b>						
$L_{CE}$					30	nH
$R_{CC'+EE'}$	terminal-chip	$T_c = 25^\circ\text{C}$		0.65		m $\Omega$
		$T_c = 125^\circ\text{C}$		1		m $\Omega$
$R_{th(c-s)}$	per module			0.04	0.05	K/W
$M_s$	to heat sink M6		3		5	Nm
$M_t$		to terminals M5	2.5		5	Nm
						Nm
$w$					160	g

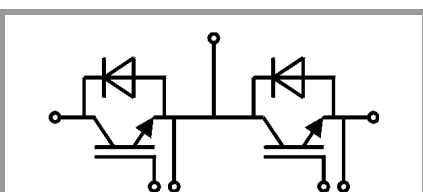

GB

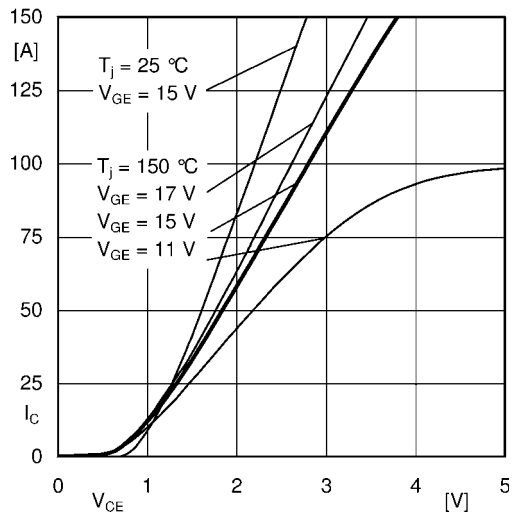

Fig. 1: Typ. output characteristic, inclusive  $R_{CC'+EE'}$

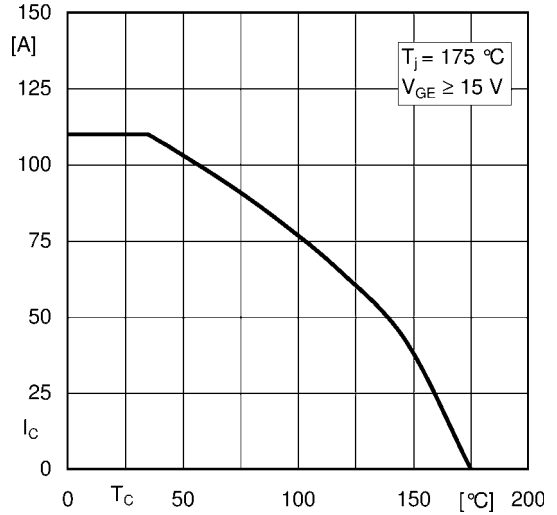

Fig. 2: Rated current vs. temperature  $I_C = f(T_C)$

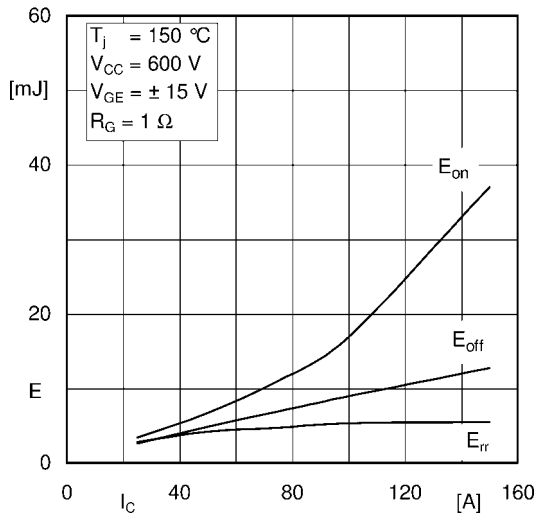

Fig. 3: Typ. turn-on /-off energy =  $f(I_C)$

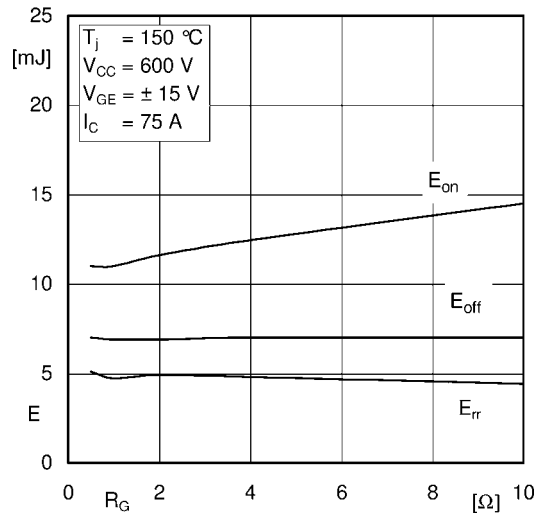

Fig. 4: Typ. turn-on /-off energy =  $f(R_G)$

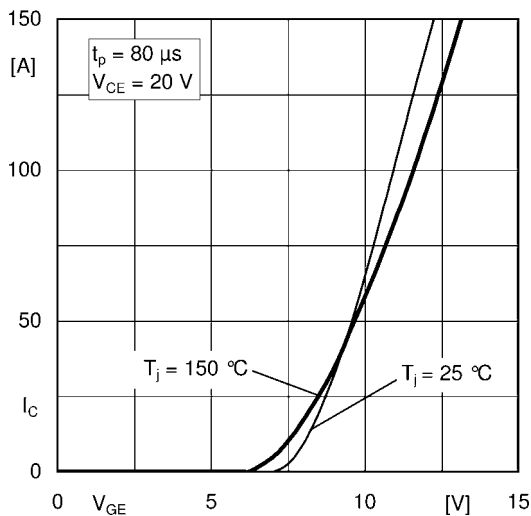

Fig. 5: Typ. transfer characteristic

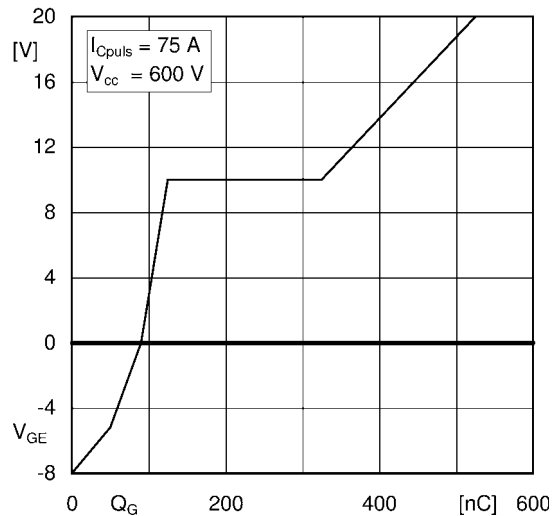

Fig. 6: Typ. gate charge characteristic

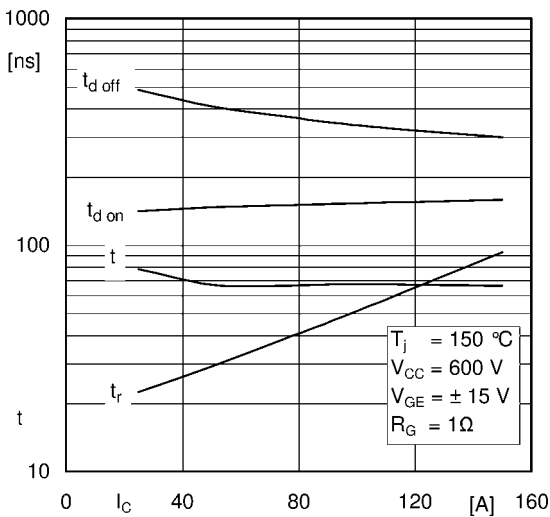

Fig. 7: Typ. switching times vs.  $I_C$

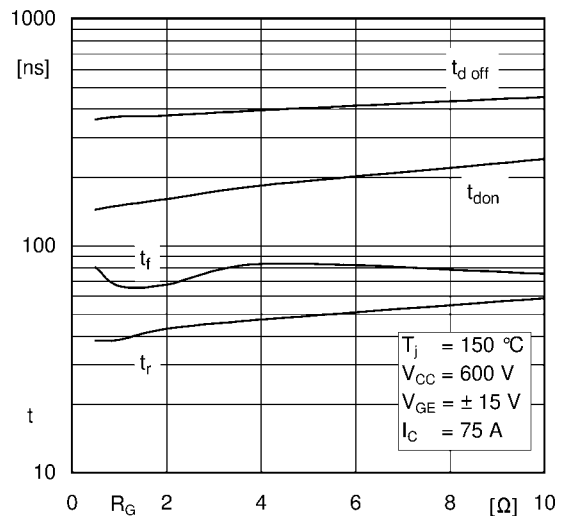

Fig. 8: Typ. switching times vs. gate resistor  $R_G$

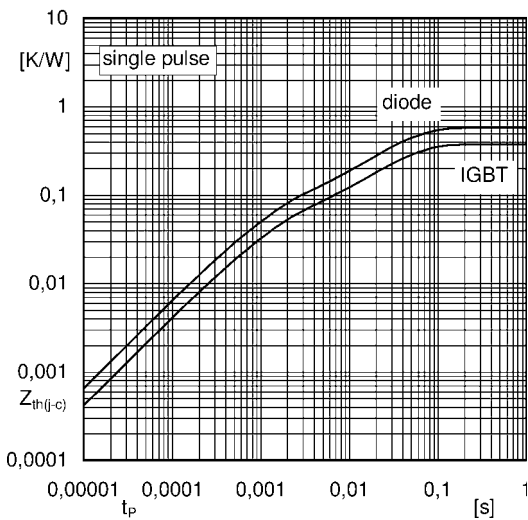

Fig. 9: Transient thermal impedance

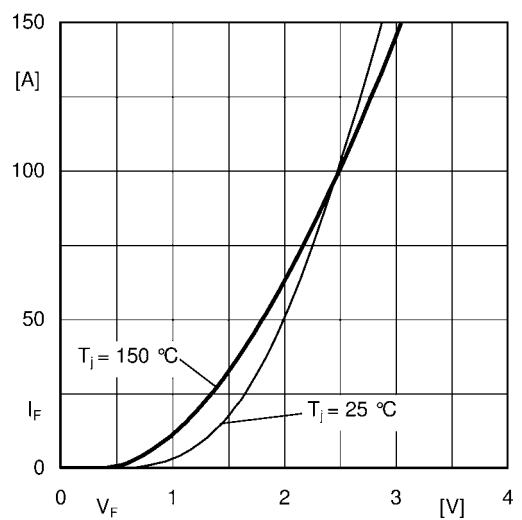

Fig. 10: CAL diode forward characteristic

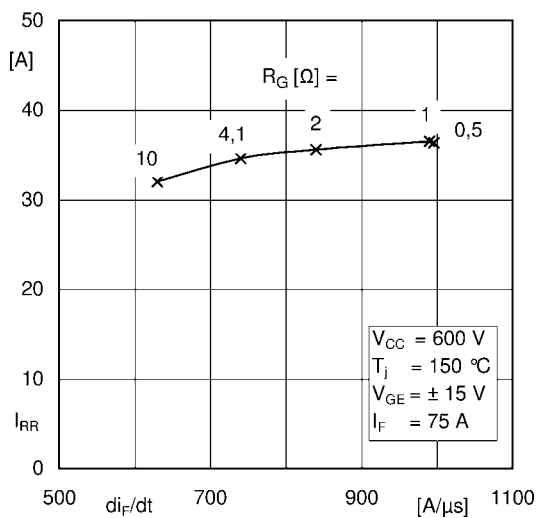

Fig. 11: CAL diode peak reverse recovery current

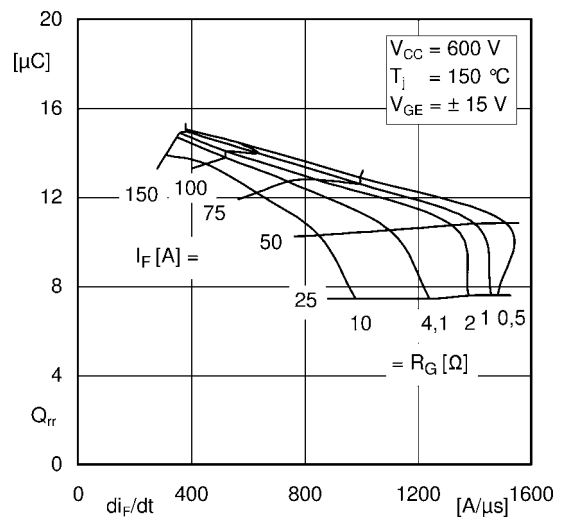
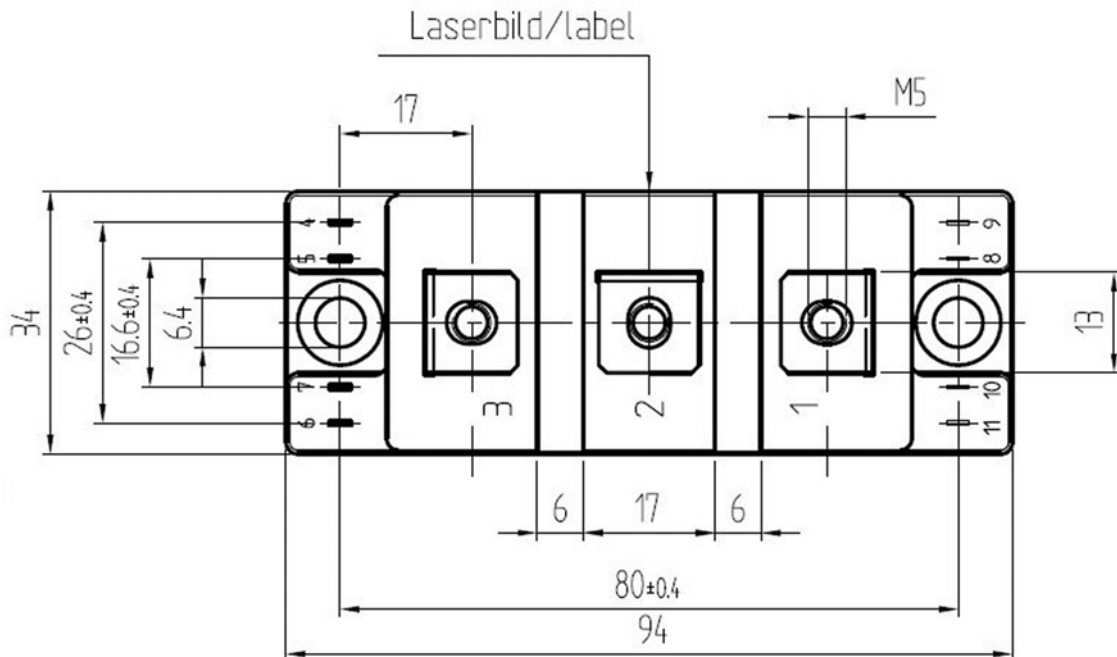
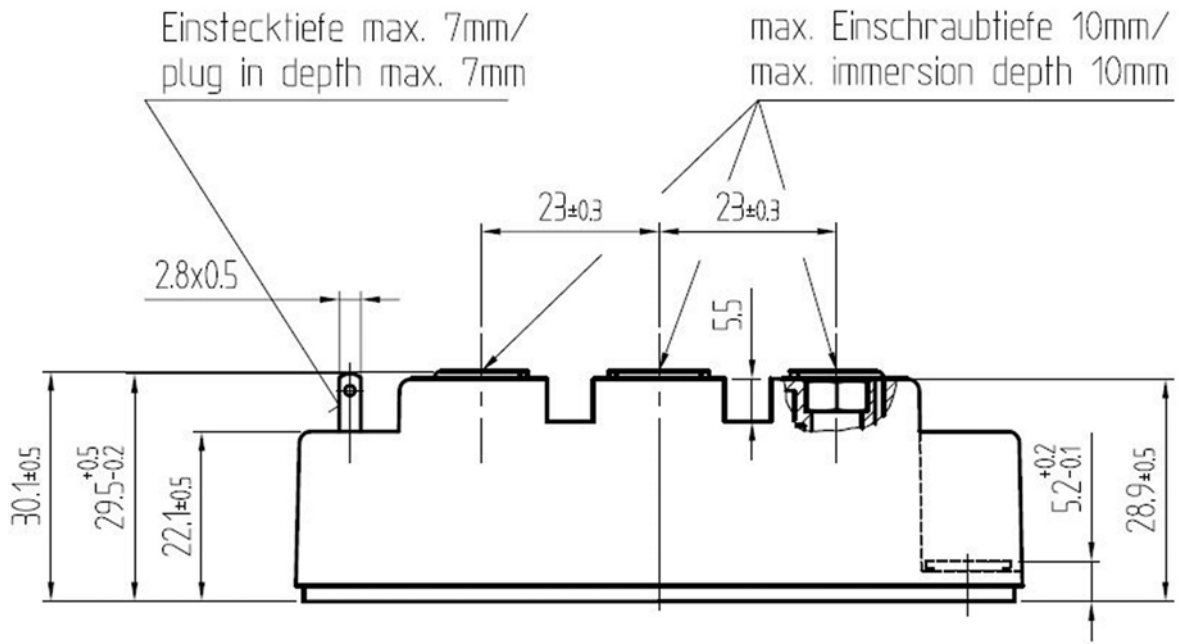
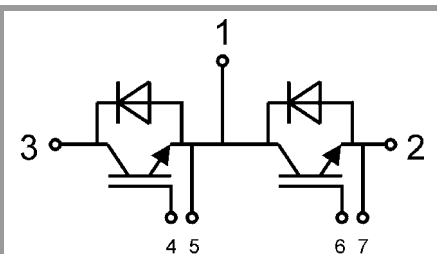

Fig. 12: Typ. CAL diode peak reverse recovery charge

# SKM75GB12T4



Semitrans 2



GB

This is an electrostatic discharge sensitive device (ESDS), international standard IEC 60747-1, Chapter IX.

This technical information specifies semiconductor devices but promises no characteristics. No warranty or guarantee expressed or implied is made regarding delivery, performance or suitability.